



NABCO Automatic Door

Comprehensive Brochure



Future-standard automatic door
with a priority on safety

NABCO Automatic Door Creating Comfortable Urban Building Environment

The high developed information and communication system as well as the change and development of industry and society have become the main reasons for changing the business environment and living environment, Buildings and cities must continuously create new, comfortable spaces. Among them, automatic doors, which provide people with easy and comfortable access, have now become an indispensable specialized technology for buildings.

NABCO, Japan No.1 automatic door brand brings more comfort and convenience to buildings through automatic doors, and achieves excellent results in various aspects with its unique technology.

NABCO automatic doors are configured with a rich product line covering various fields. This includes high-quality entrance automatic doors, the creative automatic door for interior decoration, the automatic door with barrier-free and safety features and even those with disaster and earthquake-resistant features. Additionally, the range of industrial products covers everything from ultra-large automatic doors used in giant aircraft hangars to shielding doors used in nuclear power plants.

Moreover, for the automatic door that can be widely used in stores and buildings, based on the consistent concept of automatic door system development and design, NABCO designs high-performance automatic doors with built-in microcomputer control function, and even develops automatic door sensors with advanced technologies.



Granted ISO9001, ISO14001 & ISO45001 certification
Respond to customer trust with the world standard quality system

CONTENTS

Standard Sliding Door Operator	VS-60/85/150/250/500	03
Breakout Door	GT1175BO-F0	09
Telescopic Breakout Door	GT1175BO-TP	11
Slim Breakout Door	GT1175BO-F0 (SLM)	12
Ultra-high Breakout Door	GT1175BO (M) -FO	13
Folding Door	GT-1400	14
Heavy Duty Swing Door	GT-8300 (Overhead Concealed)	15
Heavy Duty Swing Door	GT-8400 (Surface Mounted)	16
Light Duty Swing Door	GT-710	17
Middle Duty Swing Door	GT-10	18
Balance Door	GT-5	19
Heavy Duty Swing Door	GT-6 (Underground)	20
Linear Door	LS-80	21
Barrier-free Toilet Door	HDC	22
Hermetic/Sound Proof Door	NAX	23
Medical Door	MD	26
Telescopic Sliding Door	VS-TP	27
Triple Telescopic Sliding Door	VS-TTL	28
NAL Reinforced Type Sliding Door	NAL-VS	29
NLC Slim Type Sliding Door	NLC-VS	30
Speed Gate	NPKX	31
Two-wing Revolving Door	CS2A	33
Three/Four-wing Revolving Door	RL	34
Three/Four-wing Crystal Revolving Door	SSJ-A	35
Circular Door	VS-85/150CU	36
Accessories	Hardware, Sensor, Program switch, Electronic lock	38
Certificates	Test Report and Certificate	41
Projects References	Famous projects	42
Operation and Maintenance	Safety Requirements for Automatic Doors	46

NABCO×TRUST=NATRUS

With customer trust as the top priority and based on continuous improvement of technology and quality, and continuous pursuit of safety performance, NATRUS was born.



- Core components are imported with original packaging from Japan, so the quality can be ensured.
- High-power brushless DC motor ensuring longer service life.
- Hyperboloid reduction gear providing strong durability and stable operation.
- All components adopt CAN communication connection, thus realizing clear understanding of operation situation.
- Remote monitoring is configured, realizing one-button easy operation.

Anti-derail Performance Improved

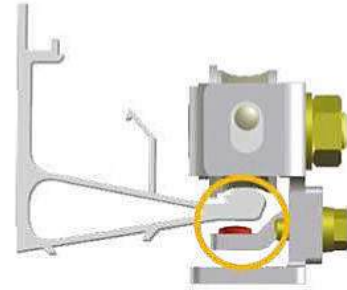

All pulleys are equipped with anti-derail mechanism, and strengthened in the structure.

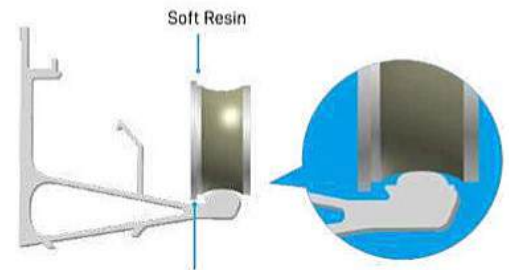

The pulley edge is modified to flange shape, thus improved the anti-derail performance.

VS-60SL N/S/HM/F

NABCO Door Motor
Developed
on the Basis of Comfort

VS-85SL N/S/HM/F

Middle-grade Automatic Door for
Office Building, Realizing
High-grade Free Access

VS-150SL N/S/HM/F

Suitable for Elegant entrance Used
in Large Buildings,
Can Drive 150kg Door

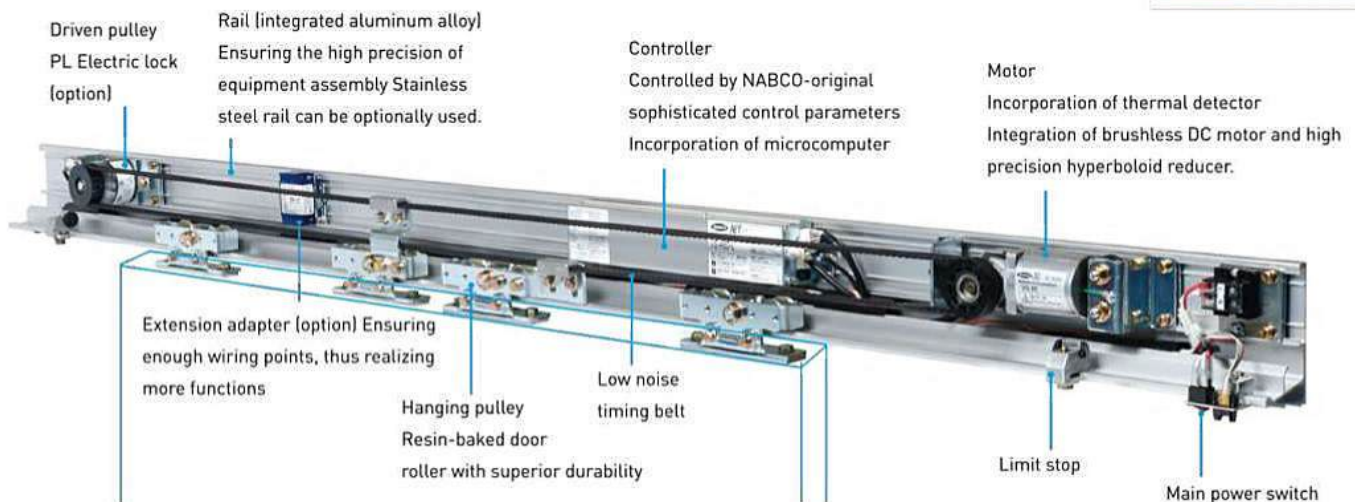

※ Core components are imported with original packaging from Japan, so the quality can be ensured. Hyperboloid reduction gear is adopted, providing strong durability and stable operation.

※ CAN, the abbreviation of Controller Area Network, is a kind of network technology implementing ISO international standard. It was originally developed as on-board system for lightweight cars, and now because of its accredited reliability and convenient fault detection function, it has attracted much attention in a wide range of fields, such as industrialequipment and medical equipment and so on. All components adopt CAN communication connection, thus realizing clear understanding of operation situation.



Unit: mm

N type VS-60/85/150SL-N

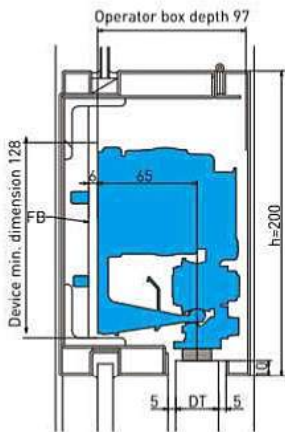

F type VS-60/85/150SL-F

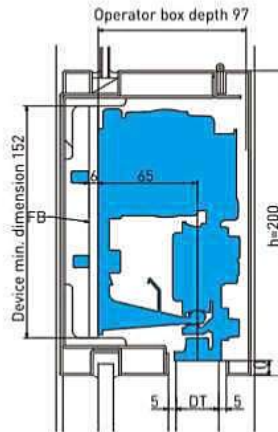

S type VS-60/85/150SL-S

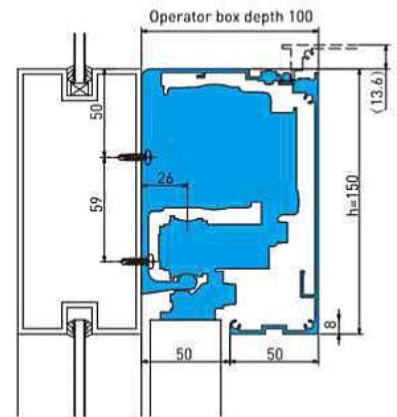

HM Slim type VS-60/85/150SL-HM

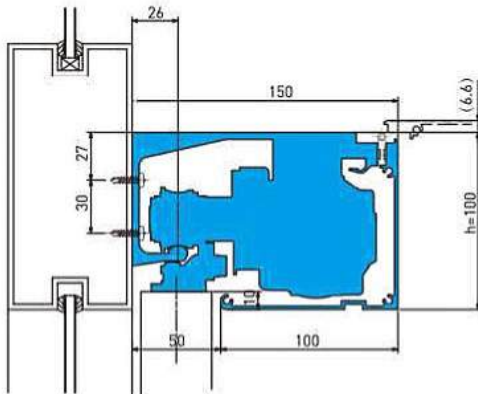

M type VS-150SL-M

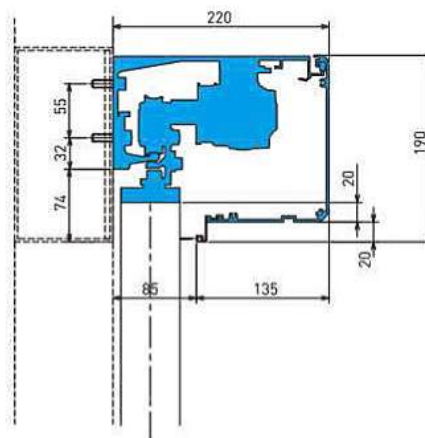

NATRUS-VS Series Standard Sliding Door Operator

Door operator type		Bi-Parting			Single				
		VS-60SL	VS-85SL	VS-150SL	VS-60SL	VS-85SL	VS-150SL		
		N/F/S/HM	N/F/S/HM/M	F	N/F/S/HM		N/S/HM/M	F	
Maximum applicable door	Applicable Door Weight (kg) x Door Quantity *1※2	60×2	85×2	120×2	150×2※1	75×1	100×1	120×1	150×1※1
	Applicable Door Width: W (mm)	650-2500							
	Ratio of Door Height / Width: DH / DW *2※3	Max 4							
Door Operation Speed (m/sec)		<0.4							
Required power capacity		AC220V-5A							
Wind Load (m/sec) speed※4		<15m/s							

N [Concealed type] — This is a device for small cross-section [100*170mm] trabeated style installation, which is suitable for stainless steel and other types of door frames.

F [Concealed type] — Since it belongs to the type of bearing large door body, please use it for the matching door body.

S [Surface mounted type] — This type of device is mounted on the surface or wall of a variety of door beams and is widely used, which is the best choice when transforming manual door into automatic door.

HM [Surface mounted type] — The drive device for horizontally sliding door which can be installed on the 100mm narrow frame.

M [Surface mounted type] — Mainly suitable for medical door series.

※1 Only F type [VS-150F15] is selectable for the single door weighing 120-150kg. N type, S type and F12 type are suitable for the single door less than 120kg.

※2 Don't exceed the allowable value of a single door weight when used. Otherwise, the fault and accident may be caused.

※3 The DH/DW ratio of single door body should be controlled within the permissible range. Otherwise, the specified performance cannot be guaranteed.

※4 The bearable wind speed during operation varies depending on the door area and other conditions. Especially in strong wind occasions, please negotiate in details.

The latest image sensor for the NATRUS-VS series automatic doors.

Equipped with two sensors, NATRUS^{+e} W doors precisely detect the movement of people in the **Wide** detection area. Through the reduction of **unnecessary door opening** and provision of **excellent accessibility**, the automatic doors will contribute to improving the indoor environment and **Well-being** of people.

In addition to providing both excellent accessibility and comfort, the automatic doors also contribute to curbing global warming.

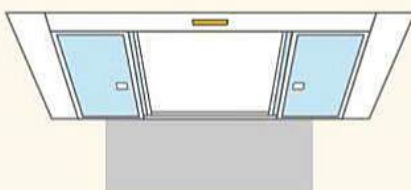

Image Sensing W



Infrared raysensor

Conventional NATRUS doors (NATRUS)



■ Conventional detection area

The NATRUS^{+e} W doors will open by predicting the vector (speed and direction) of approaching people and objects. The doors monitor the movement of people to provide them with excellent accessibility by opening at a better timing.



Infrared raysensor + Image sensor

NATRUS^{+e} W

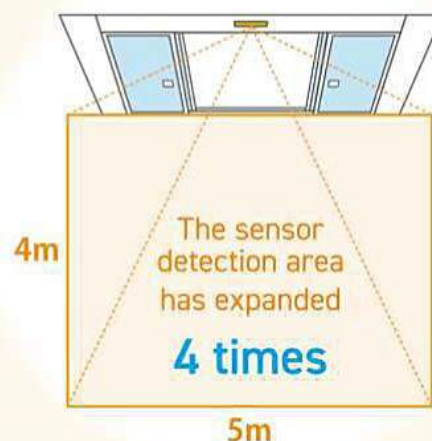

Reducing unnecessary openings



Pedestrian flow detection to determine if the doors will open or not.

Within the wide pedestrian flow detection area (5 m in width x 4 m in depth), the state-of-the-art sensing technology detects the movement of people to provide greater detection performance. That allows automatic doors to discern who is intending to pass through and who is just standing by or passing by. The doors then open only for people wanting to pass through.

The doors will open.

Movement of people who will head toward the doors

Sensor detection area

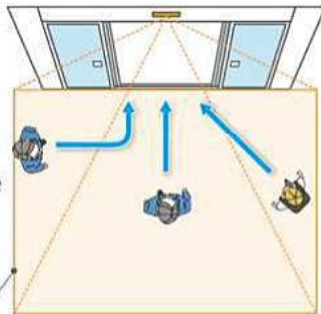

The doors will not open.

Movement of people who will not head toward the doors

Sensor detection area

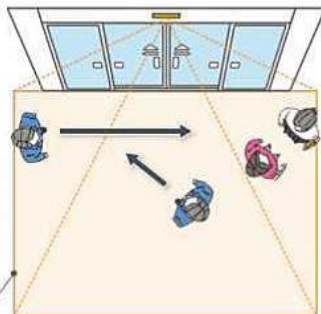

Providing accessibility according to the movement



The doors will predict the pedestrian's flow for smooth opening

The Image Sensing W system appropriately estimates walking speed. By predicting the time required for the person to reach the doors, the doors will open in a timely fashion both for people walking at a normal pace and those approaching more slowly. Even for a person using a wheelchair or a cart, the doors will open at the right time to allow the person to pass through without any fuss.

At a normal speed



The doors will open by predicting the vector (speed and direction) of people and objects

At a slow speed



Note: When a person approaches the doors from the front, the doors will open at the right time based on the person's vector (speed and direction) of approach. When a person approaches the doors from different angles, for example, from the side, the doors may open at a different timing.

Easily expand functionality by just replacing the sensors

The newly developed NATRUS⁺e W sensor is the same size as that of the conventional NATRUS sensor, so you can easily replace the conventional sensor with the new one.

NATRUS
NATRUS Sensor



NATRUS⁺e W
NATRUS⁺e W Sensor



Improvement of the indoor environment

Reducing unnecessary automatic door openings helps reduce the inflow of hot/cold air from outside into the indoor space, thereby contributing to providing users with a stress-free and comfortable indoor environment.



Better Accessibility

Based on the prediction of the vector (speed and direction) of approaching people and objects, the doors will open in a right time, even for those using a wheelchair or a cart.



Barrier-free

No need to press the button to open the door, making it easier for the wheelchair users and cart users to pass through the doors. The doors are thus suitable for use at facilities that need to be barrier-free, such as stations, station buildings, commercial facilities and educational institutions.



Product Features

1. Small size, but with super driving force.
2. The extra-heavy door body, installed in broad access areas, can drive super-heavy tall door body and decorative door body. It is suitable for double-leaf sliding doors with single leaf less than 250kg and single-leaf sliding doors with the maximum weight of 700kg.

Other External-mounted Devices Frame VS-250SL-M View

Built-in Device VS-250SL Longitudinal Sectional View

Built-in Device VS-250TL Longitudinal Sectional View

Built-in Device VS-250SL Reducer Longitudinal Sectional View

单位:mm

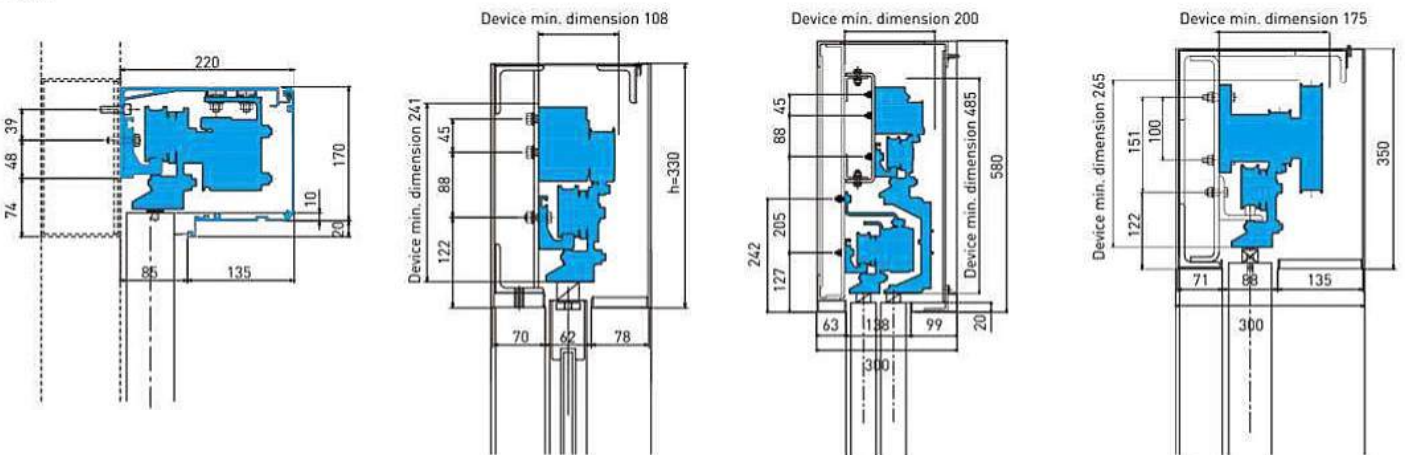

VS-250SL Heavy Standard Sliding Door Operator

		Double-leaf Sliding	Single-leaf Sliding	Telescoping Double Doors	Telescoping Single Door	Double-leaf Sliding	Single-leaf Sliding	-
Door operator type		VS-250 SL	VS-250 SL	VS-250 SL	VS-250 SL	VS-250 reducer	VS-250 reducer	-
Maximum applicable door	Applicable Door Weight(kg) x Door Quantity	250×2	500	165×4	325×2	350×2	700×1	[Note 1]
	Ratio of Door Height / Width: DH / DW (m ²)	Max 5	Max 5	Max 3.5	Max 7	Max 6	Max 8	[Note 2]
	Applicable Door Width: DW (mm)	900-2705	1200-3100	1000-1650	1000-2000	1000-2500	1000-4500	[Note 3]
	Ratio of Single door DH/DW	Max 3.0	Max 3.0	Max 3.0	Max 3.0	Max 3.0	Max 3.0	[Note 4]
Door Operation Speed (m/sec)		<0.4m/s	<0.4m/s	<0.45m/s	<0.45m/s	<0.22m/s	<0.22m/s	-
Required power capacity		AC 220V-5A	AC 220V-5A	AC 220V-5A	AC 220V-5A	AC 220V-5A	AC 220V-5A	-
Operationable standard wind speed		<15m/s	<15m/s	<15m/s	<15m/s	<15m/s	<15m/s	[Note 5]

[Note 1] Don't exceed the allowable value of a single door weight when used. Otherwise, the fault and accident may be caused.

[Note 2] Don't exceed the allowable value of a single door area when used. Otherwise, the fault and accident may be caused. In addition, the indoor door that is not affected by wind pressure is not so strict in the allowed area. Please specify the service conditions when ordering.

[Note 3] The width of the single-leaf door body is the standard applicable size. If the wide-body door is to be used, please consult the production possibility and delivery date.

[Note 4] The DH/DW ratio of single door body should be controlled within the permissible range. Otherwise, the specified performance cannot be guaranteed.

[Note 5] The bearable wind speed during operation varies depending on the door area and other conditions. Especially in strong wind occasions, please negotiate in details.



Front View

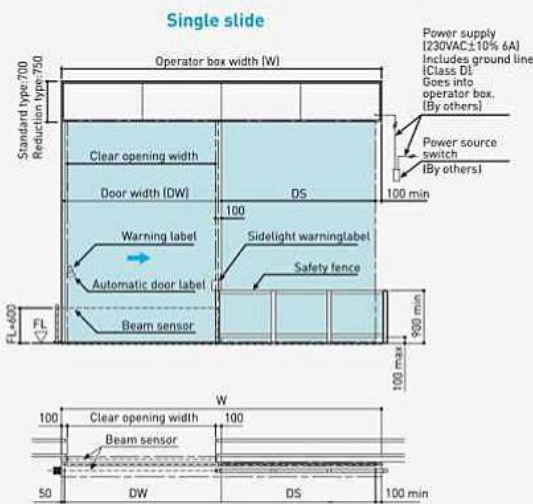
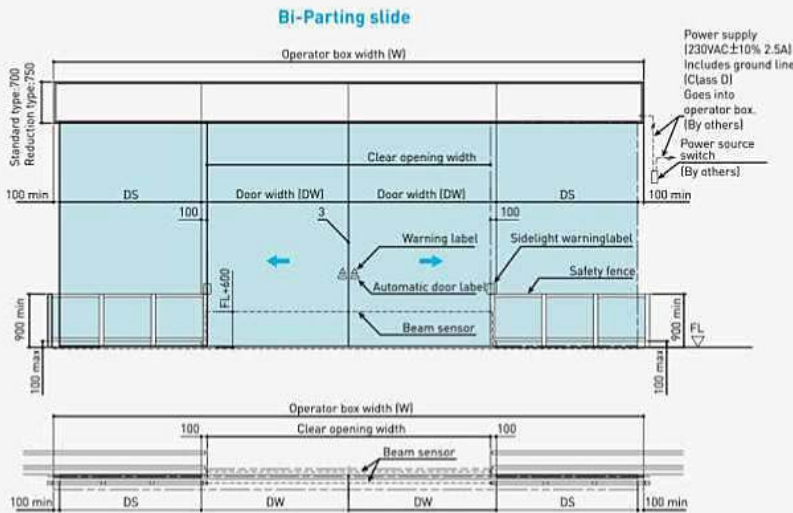

Sectional view

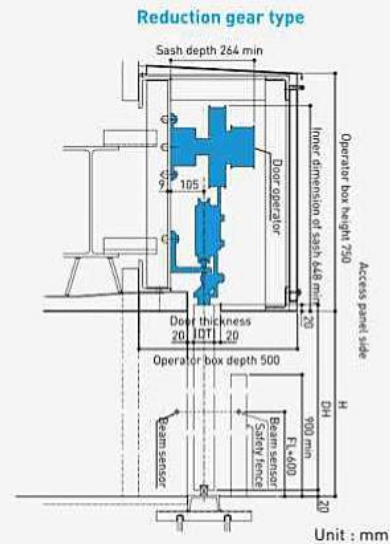
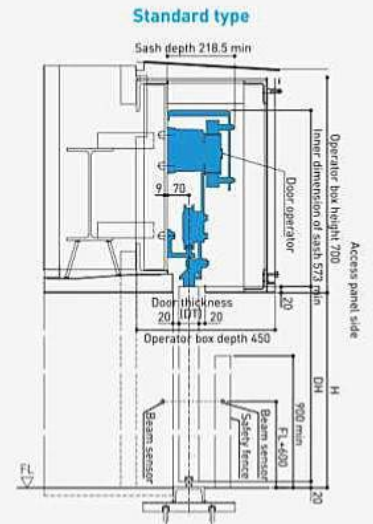

Specifications of Standard type and Reduction gear type

Product Name		V-500SL			
Geared Motor Type		V-500SL			
Openable Type		Standard type (Elevation)		Reduction gear type (Elevation)	
Door Type		Bi-Parting	Single	Bi-Parting	Single
Applicable Door Mass (kg) × Door Quantity ※1		500×2	1000×1	1000×2	2000×1
Applicable Door Width: DW (mm)		3100	6100	6100	10100
Applicable Door Height: DH		4500		4500	
Required Power Capacity		200VAC ± 10%, 50/60Hz, 6A ※2		200VAC ± 10%, 50/60Hz, 6A ※2	
Door Operation Speed (m/sec)		0.1 - 0.5 ※3		0.1 - 0.3 ※3	
Available ambient conditions	Ambient temperature	-10 to 50 C			
	Ambient humidity	20 to 85% RH (no icing or condensation)			
	Electromagnetic field immunity	Industrial environment (IEC/JIS C 61000-6-2)			

※1 The door should be used under conditions where the door unit weight will not exceed the value defined in the specification. If the weight exceeds the specification, malfunction or accident will occur.

※2 With a transformer specified by NABCO

※3 The speed varies according to the door weight or site environment.



Product Features

1. Under the action of 110N thrust, both the movable door and fixed door can be opened 90°.
2. Full-profile frame, with no need of additional external frame, which is more beautiful.
3. Light weight, convenient installation and high traffic efficiency.
4. After the movable leaf is opened horizontally, it can be pushed manually at any position, so as to reach the larger opening width.
5. At ordinary times, it is automatic sliding door that can be opened freely and comfortably. Its door body can be opened to 2 times of the original width as needed, which can strongly facilitating carrying large items or holding large-scale events



Application Example

- Suitable for hospitals, transportation facilities, hotels, shopping malls, supermarkets, 4S stores and other high traffic areas.
- Be configured with reliable safety system.
- Be granted with ANSI/BHMA A156.10 US market mandatory certification.

GT1175B0-FO Breakout Door

Details		
Item	Standard	Options
Door leaf material	Aluminum	-
Glass material	Tempered glass	Laminated glass, Insulated glass
Starting probe	NH-203B	Optional
Safety beam	NP-01 (1 piece)	NP-01 (2 piece)
Electronic lock	-	Optional
Floor lock	-	Optional
Surface treatment	Silver oxidation	Coating, non-ferrous oxidation, stainless steel
Mullion (mm)	54	102
Upper frame (mm)	Movable 102/Fixed 165	-
Lower frame (mm)	102	254
Transom (mm)	-	51/102/204, 1 piece ~
Longitudinal frame (mm)	44x114	51x178
Transom window	-	Optional
Ground rail	Arrangement of fixed leaf position	Full length arrangement

Notes:

1. When the width of movable leaf is greater than 1370mm, or its weight is more than 90kg, the supporting wheel needs to be installed at the bottom of door leaf.
2. When the width of the door leaf is greater than 1500, the transom has to be added.

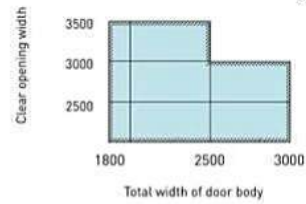
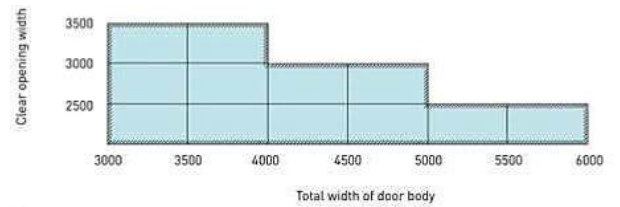
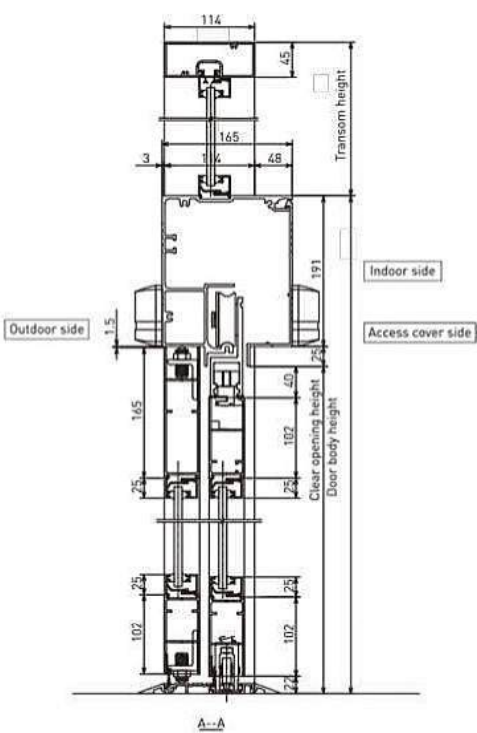
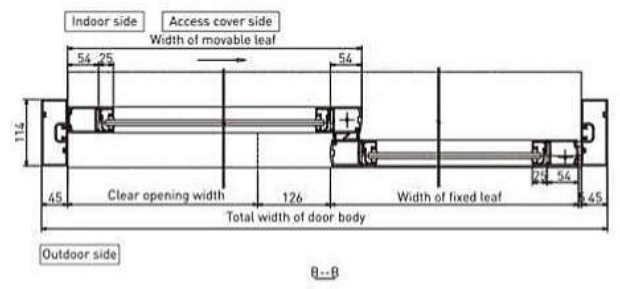
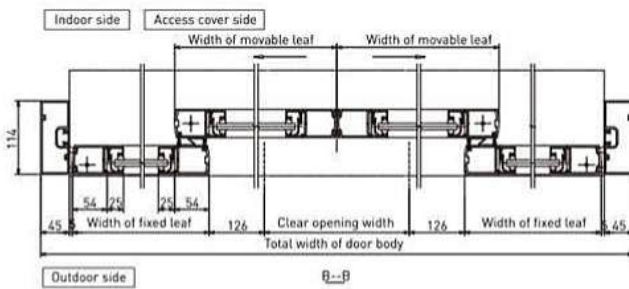
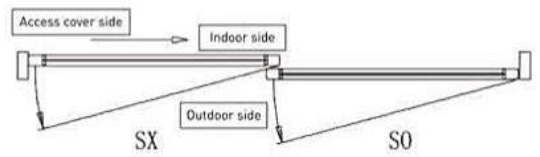
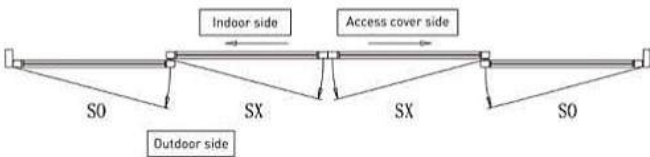
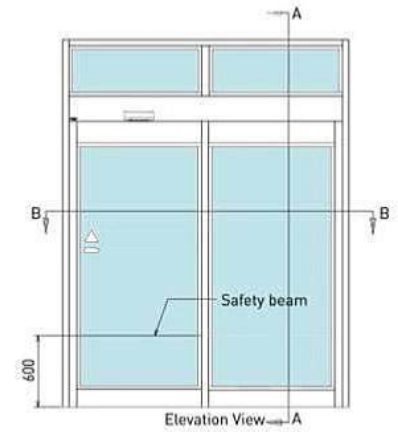
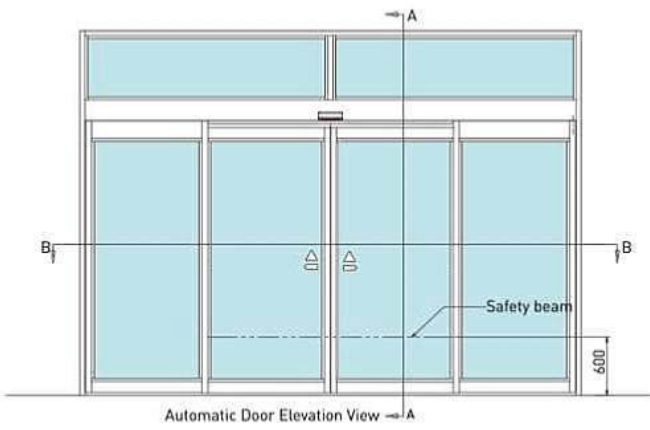

Technical Parameters of Double Door

Standard Dimensions					
No.	Total width of door body	Clear opening width	Maximum evacuation width	Width of movable leaf	Width of fixed leaf
01	3000	1203	2682	785	723
02	3500	1453	3182	910	848
03	4000	1703	3682	1035	973
04	4500	1953	4182	1160	1098
05	5000	2203	4682	1285	1223



Product Features

1. Compared with GT-1175BO-FO, the opening width is increased by 25%, improving traffic efficiency.
2. Anodized surface, ensuring durable performance.
3. Be equipped with brushless motor system, ensuring the running of drive system.
4. Double brush, insulated from outside temperature.
5. Be equipped with sensor system, conforming to ANSI156.10, thus improving the security.

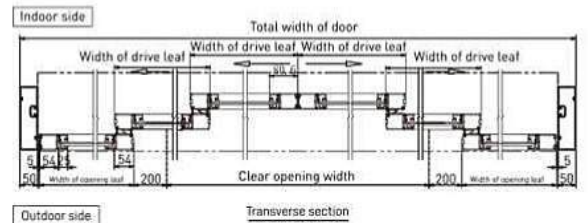
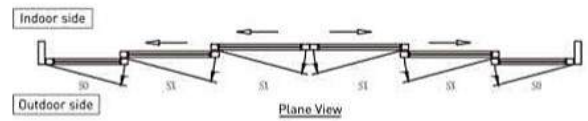

GT-1175BO-TP Telescopic Breakout Door

Details		
Item	Standard	Options
Door leaf material	Aluminum	-
Glass material	Tempered glass	Laminated glass Insulated glass
Starting probe	NH-203B	Optional
Safety beam	NP-01 (1 piece)	NP-01 (2 piece)
Electronic lock	-	Optional
Floor lockl	-	Optional
Surface treatment	Silver oxidation	Coating, non-ferrous oxidation
Mullion (mm)	54	102
Upper frame (mm)	Movable 76,102/Fixed 165	-
Lower frame (mm)	102	254
Transom (mm)	-	51/102/204, 1 piece ~
Longitudinal frame (mm)	50x180	51x178
Transom window	-	Optional
Ground rail	Full length arrangement	-

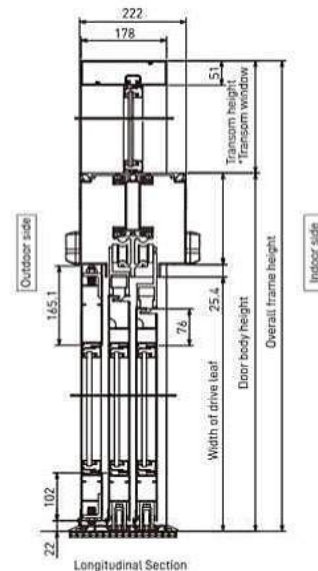



Product Features

1. Thin frame is used with beautiful appearance.
2. Anodized surface, ensuring durable performance.
3. Be equipped with brushless motor system, ensuring the running of drive system.
4. Double brush, insulated from outside temperature.
5. Be equipped with sensor system, conforming to ANSI 156.10, thus improving the security.

GT-1175BO-F0 (SLM) Slim Breakout Door

Details		
Item	Standard	Options
Door leaf material	Aluminum	-
Glass material	Tempered glass	Laminated glass Insulated glass
Starting probe	NH-203B	Optional
Safety beam	NP-01 (1 piece)	NP-01 (2 piece)
Electronic lock	-	Optional
Floor lock	-	Optional
Surface treatment	Silver oxidation	Coating, non-ferrous oxidation
Mullion (mm)	25	-
Upper frame (mm)	Movable 90/Fixed 153.5	-
Lower frame (mm)	115	-
Transom (mm)	-	51/102/204, 1 piece ~
Longitudinal frame (mm)	44x114	51x178
Transom window	-	Optional
Ground rail	Full length arrangement	-

Notes:

1. When the width of movable leaf is greater than 1370mm, or its weight is more than 90kg, the supporting wheel needs to be installed at the bottom of door leaf.
2. When the width of the door leaf is greater than 1500mm, the transom has to be added.

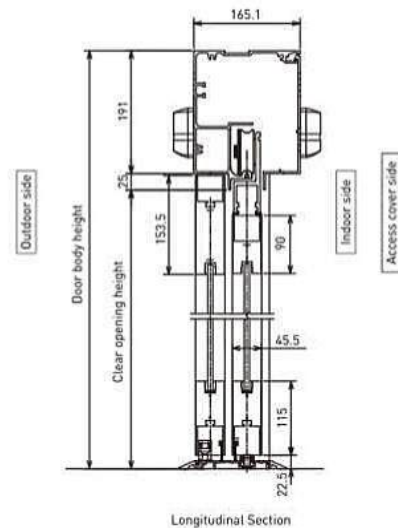
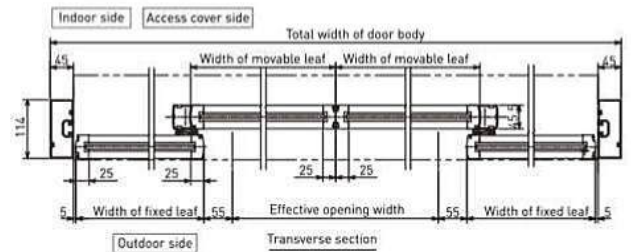
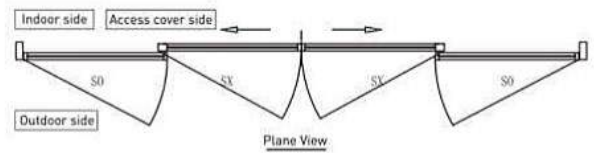



Product Features

1. Be configured with high-strength aluminum alloy frame.
2. The clear opening height up to 4m.
3. Can be stably opened 90° even if the door body is 4 meters high.
4. Can strongly facilitating carrying large items or holding large-scale events.

GT-1175B0-F0 (SLM) Slim Breakout Door

Item	Details	
	Standard	Options
Door leaf material	Aluminum	-
Glass material	Tempered glass 10mm	-
Starting probe	NH-721	Optional
Safety beam	NP-01 (1 piece)	NP-01 (2 piece)
Electronic lock	-	Optional
Floor lock	-	Optional
Surface treatment	Silver oxidation	Coating, non-ferrous oxidation
Mullion (mm)	102	-
Upper frame (mm)	Movable 102/Fixed 16	-
Lower frame (mm)	165	-
Transom (mm)	1 piece	Quantity optional
Longitudinal frame(mm)	51x178	-
Transom window	-	-
Ground rail	Arrangement of fixed leaf position	Full length arrangement

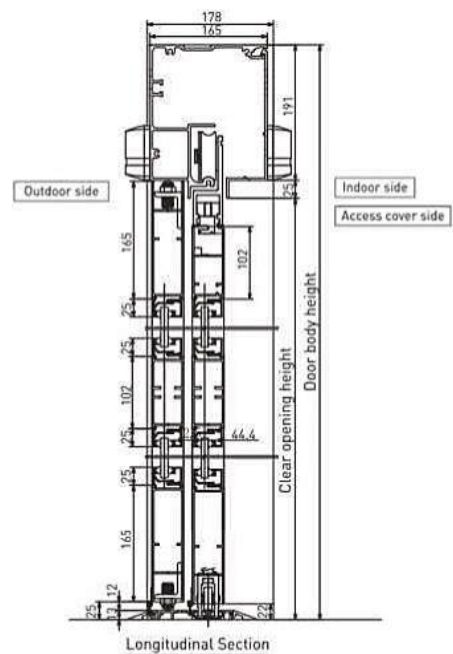
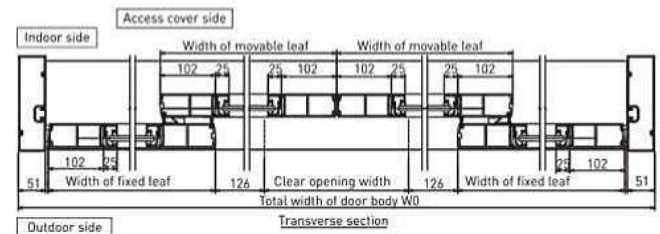
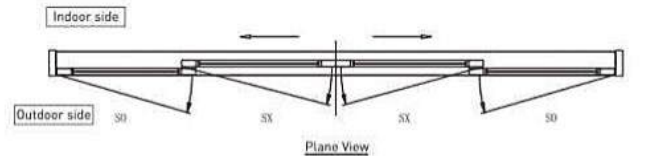



Product Features

1. Equipment imported from USA, ensuring the quality.
2. For narrow passageways, can provide wide opening in limited space, ensuring easy access.
3. Hinge of door body is designed with anti-pinch structure to improve the safety of door body.
4. Have emergency opening function.
5. Conforming to ANSI 156.10, and be granted with UL, ULL, NAMI and FPA certification.

GT-1400 Folding Door

Details		
Item	Standard	Options
Door leaf material	Aluminum	-
Glass material	Tempered glass	Laminated glass, Insulated glass
Starting probe	EAGLE6	Optional
Electronic lock	-	Optional
Floor lock	-	Optional
Surface treatment	Silver oxidation	Coating, non-ferrous oxidation
Mullion (mm)	54	-
Upper frame (mm)	102	-
Lower frame (mm)	102	-
Transom (mm)	-	51/102/204
Longitudinal frame(mm)	60x140	-
Transom window	-	Optional
Ground rail	-	Full length arrangement

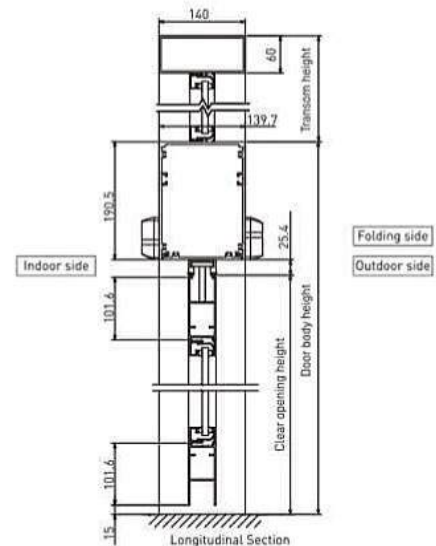
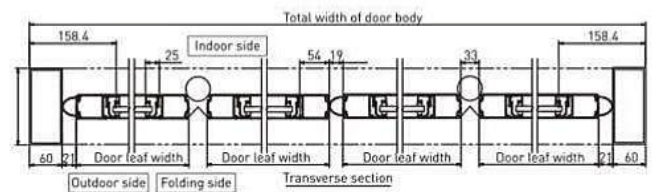
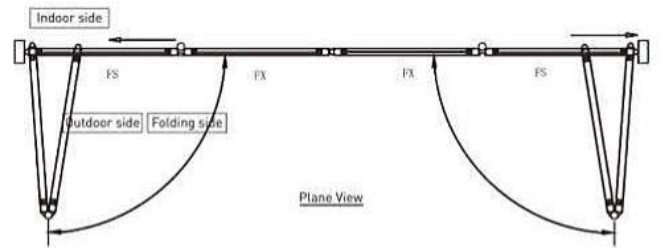



Product Features

1. Equipment imported from USA, ensuring the quality.
2. Strong driving force, super typhoon resistance.
3. Equipment installed internally, no connecting lever exposed after the door closed, ensuring elegant appearance.
4. Be equipped with microelectronic controller, ensuring smooth and efficient operation.
5. For double door, one leaf opened inwards and the other outwards can be realized automatically; In case of emergency, both leaves can be opened manually in the evacuation direction.
6. Conforming to ANSI 156.10, and be granted with USA UL, ULC and CSFM certification.

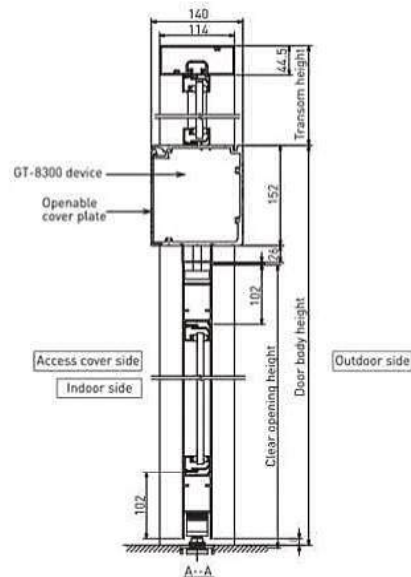
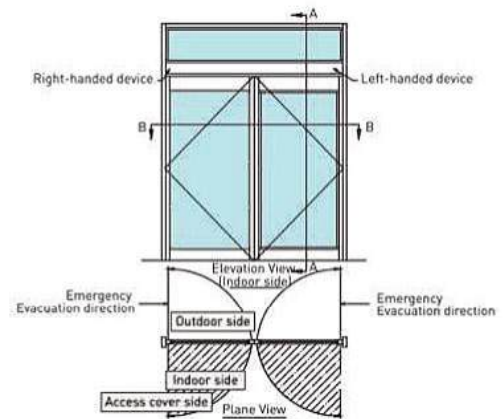
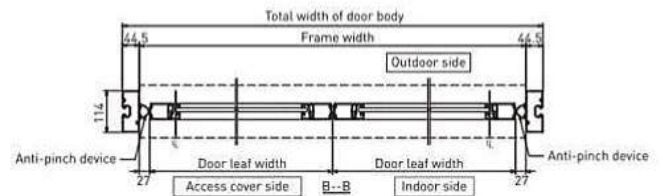

GT-8300 Heavy Duty Swing Door (Overhead Concealed)

Details			
Device Model		2 Sets of GT-8300	1 Set of GT-8300
Type of Door Body Opening or Closing		Double door (two leaves * 90° opening)	Single door (one leaf * 90° opening)
Single leaf weight * leaf quantity	Standard type	150x2	150x1
	Extra-heavy type	(151-250)x2	(151-250)x1
Electromechanical beam length (mm)	Standard type	> 1841	> 1171
	Transformer externally mounted (controller built in)	1637-1840	966-1170
	Transformer and controller both externally installed	1359-1636	701-965
Single door area: DW × DH (m ²)		MAX4.5	
Door thickness: DT (mm)		44	
Function in case of power failure		Manual opening ~ automatic closing	
Outline dimension of device		W940 × H152 × D148	
Surface color of device		Silver	
Average opening and closing speed		~35°/s	
Required power capacity		AC 220V-5A	AC 220V-2.5A



Product Features

1. Equipment imported from USA, ensuring the quality.
2. Strong driving force, super typhoon resistance.
3. Without changing the original manual door, it can be easily changed into an automatic sliding door, ensuring very simple construction.
4. Be equipped with microelectronic controller, ensuring smooth and efficient operation.
5. For double door, one leaf opened inwards and the other outwards can be realized automatically; In case of emergency, both leaves can be opened manually in the evacuation direction.
6. Conforming to ANSI 156.10, and be granted with USA UL, ULC and CSFM certification.

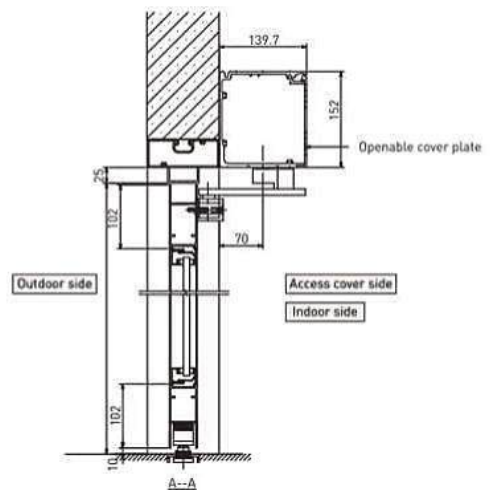
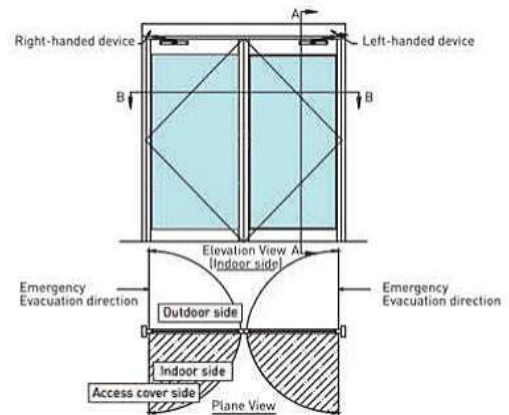
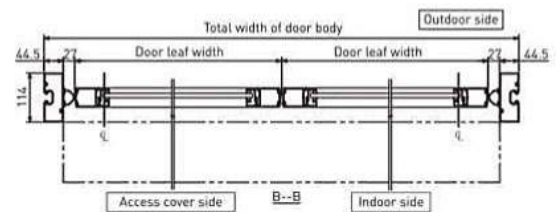

GT-8400 Heavy Duty swing Door (Surface Mounted)

Details			
Device Model		2 Sets of GT-8400	1 Set of GT-8400
Type of Door Body Opening or Closing		Double door (two leaves * 90° opening)	Single door (one leaf * 90° opening)
Single leaf weight * leaf quantity	Standard type	150x2	150x1
	Extra-heavy type	(151-250)x2	(151-250)x1
Electromechanical beam length (mm)	Inward opening	Standard type	>1765
		Transformer externally mounted (controller built in)	1560-1764
		Transformer and controller both externally installed	1295-1559
	Outward opening	Standard type	>1880
		Transformer externally mounted (controller built in)	1675-1879
		Transformer and controller both externally installed	1410-1674
Single door area: DW × DH (m ²)		MAX4.5	
Door thickness: DT (mm)		44	
Function in case of power failure		Manual opening – automatic closing	
Outline dimension of device		W940 × H152 × D148	
Surface color of device		Silver	
Average opening and closing speed		~35°/s	
Required power capacity		AC 220V-5A	AC 220V-2.5A



Product Features

1. Core components are imported from USA, so the quality can be ensured.
2. Door opens automatically after pushing (pulling) it gently.
3. After loosening, it still can remain open for a while, and the wheelchair also can easily pass through it.
4. In the case that the door body cannot be easily opened, it can be opened by a switch installed at a certain distance.
5. In case of power failure, it can be opened manually, and then the door body can be closed silently and automatically.
6. It can easily transform the existing manual sliding door into automatic door.
7. Conforming to ANSI 156.10, and be granted with USA UL, ULC and CSFM certification.

GT-710 Light Duty Swing Door

Details		
Device Model	2 Sets of GT-710	1 Set of GT-710
Type of Door Body Opening or Closing	Double door (two leaves * 90° opening)	Single door (one leaf * 90° opening)
Single leaf weight × leaf quantity	90x2	90x1
Maximum applicable door	Single door area: DW × DH (m²)	Max.2.6
	Single door width: DW (mm)	813-1219 (Min. 762)
	Single door thickness: (mm)	30-50 (Please make negotiation if outside this scope)
	Reference	
	12mm tempered glass door: DW×DH (mm)	1067×2134
	6mm framed glass door: DW× DH (mm)	1000×2100
Assisting function	Push the 10cm door to open automatically with 29.4N force	
Function in case of power failure	Manual opening - automatic closing	
Outline dimension of device	W880 × H158 × D145	
Surface color of device	Silver, tawny	
Average opening and closing speed	-35°/s	
Required power capacity	AC 220V-3A	AC 220V-1.5A

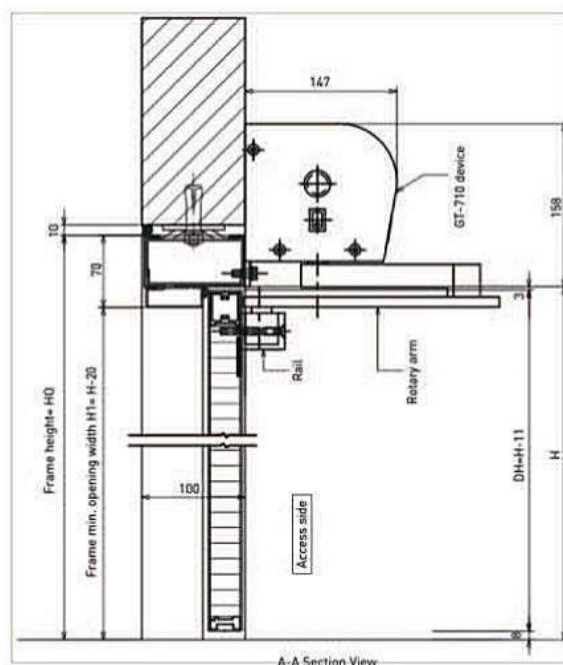



The lighting program selection button and the main control switch are integrated into the side cover, ensuring the intuitive operation.



Standard support arm: can be optionally installed on the beam or door leaf according to different site conditions.

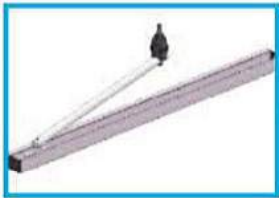

Sliding support arm: automatic side-hung door drive with sliding arm and push/pull function, which is a kind of common and ornamental building solutions.

Product Features

1. Suitable for both left and right opening, provide a variety of functions, and easy to use.
2. A wide range of options to provide customized and automated solutions.
3. Switzerland NABCO imported equipment with highly consistent components and good reliability.
4. Electromechanical drive device, ensuring the silent and stable operation of automatic door.
5. Drive mechanism with low energy consumption and full power, can be used in a variety of applications.
6. Ensure that the automatic door can remain fully open or fully closed in the case of high wind based on its unique wind compensation characteristics.

GT10 Middle Duty Swing Door

Product Information	
Drive device	Standard
Power transfer	Standard support arm
	Sliding support arm
Drive device dimensions	70mm height
	730mm width
	125mm depth
Drive device weight	8.2kg
Environment temperature	-15...+50°C
May only be used in dry rooms	Maximum RH 85 %
Level of protection	IP 20
Working voltage	230 VAC (+10/-15 %), 50 Hz
Power supply provided by the customer	230 VAC (+10/-15 %), 50 Hz, 10/13 A
Drive device power	max. 350 W
Motor rated power	100 W
Supplied external power	24 VDC (±10 %), 1.4 A
Shaft output torque	Fixed value = 56 mm
	Max. value = 165 mm
Lintel depth	Sliding bar: pl -50/+150 mm ps -50/+150 mm
Door opening angle	Max. 105°
Door weight	Max. 150kg
Door weight	730...1'100 mm (lintel installation)
	800...1'100 mm (door installation)
Opening speed	2,4...20s adjustable (Max. 40°/s)
Closing speed	2,4...20s adjustable (Max. 40°/s)
Force close scope (no power supply)	=10...15° non-adjustable
Force close buffer (no power supply)	Stepless adjustable (control the fine adjuster)
Open holding time	0...60 s
Night open holding time	0...180 s

Installation & assembling options

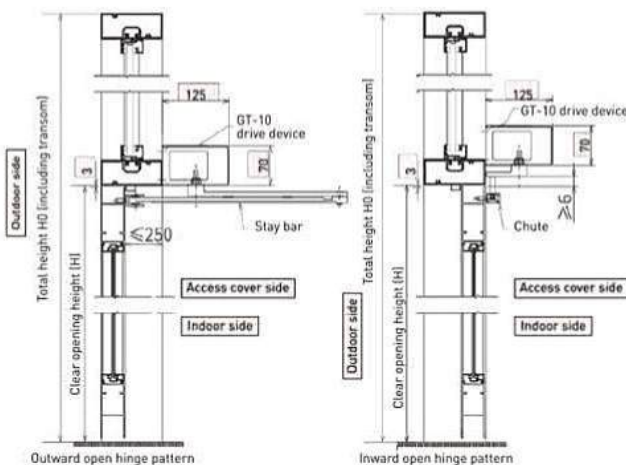



Product Features

1. The door opening force is only about half of that of the ordinary manual doors, especially in windy occasions, the easy-to-push performance is more obvious. (Compared with the [hardware series] products produced by NABCO.)
2. The balance door can be used to replace the spring door, and its door body can be positioned after opening 90 degrees, which is more convenient when evacuating people.
3. The opening path of the door is elliptical, and the door body will not occupy a lot of space after opening.
4. Its structure is very safe, thus the risk of injury caused by door falling down due to ground decline is greatly reduced.
5. Since the combination form of its door body is free, it can be installed independently as the entrance of buildings, and also can be used with the automatic door.
6. The surface decoration of the door body is diversified, which can meet the requirements of different customers.
7. There is no need to groove on the ground, so its site construction is relatively simple.

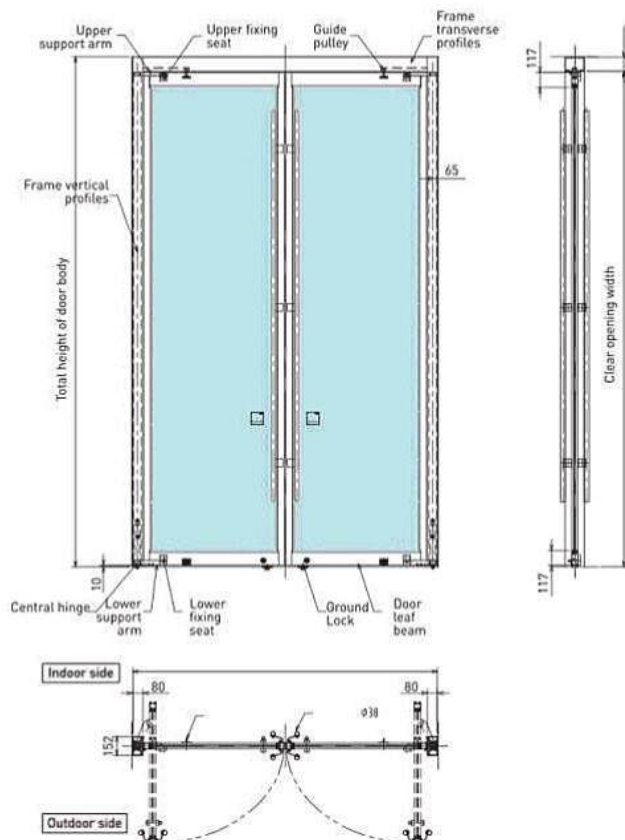

GT-Z/B Balance Door

Balance Door Model	Applicable Door Weight (kg)	DW (mm)		Max. OH (mm)	Min. Door (mm)
		Single Door	Double Door		
GT-Z5150	150	1100	2200	3000	760
GT-Z5200	200	1250	2500	4000	760
GT-Z5400	400	1500	3000	4500	900
GT-Z5500	500	1800	3600	4800	900
GT-B5150	150	1100	2200	3000	900
GT-B5300	300	1250	2500	4000	900
GT-B5500	500	1800	3600	4800	900

11 Heavy Duty Swing Door (Underground)

GT-6 Series



Product Features

1. Underground operator makes use of the output shaft of buried motor to realize the automatic opening and closing of door body through the lower drive.
2. Its opening and closing speed is 3-8s adjustable.
3. The open holding time is 0-30s adjustable.
4. Mode selection. Manual open, manual close, magnetic lock, electric lock.
5. Five open/close control modes: Automatic, normally open, manually open, normally close & one-way access.

GT-6 Series Heavy Duty Swing Door (Underground)

Details		
Device Model	GT-610	GT-620
Equipment Dimension	296×132×84mm	358×184×108mm
Controller dimensions	45×64×350mm	45×64×350mm
Weight	6.5kg	11.5kg
Axis distance	70mm	110mm
Max. door weight	150kg	250kg
Max. door width	900mm	1100mm
Max. output torque	70Nm	120Nm
Max. power	35W	55W
Opening angle	45 ~ 135° adjustable	
Opening direction	Open to the left or right; single door and one-way 90° open, double door and one-way 90° open	
Level of protection	IP67	
Standby power	W<6W	
Operating temperature	-40 ~ 85°C	
Noise	<60dB	
Power supply	220V±10%,55Hz	
Safe return sensitivity	10 gears adjustable	
Closing pressing force	10 gears adjustable	
Opening/closing slow-stop setting	20 gears adjustable	
Input port setting	Automatic open, normal open, inching open, inching close, etc.	
Opening/closing torque	24 gears adjustable	
Windproof mode	Can be set or manually switched	
Closing mode	Manual closing, automatic closing	
Protection mode	Lock release, access control, automatic reset	
Internal and external safety light curtain interface	Safety passing monitoring	
Dual computer linkage	The double-door linkage opening mode can be set through the linkage cable.	
Fire emergency input	Input contact	

Dimensions of Heavy Duty Swing Door

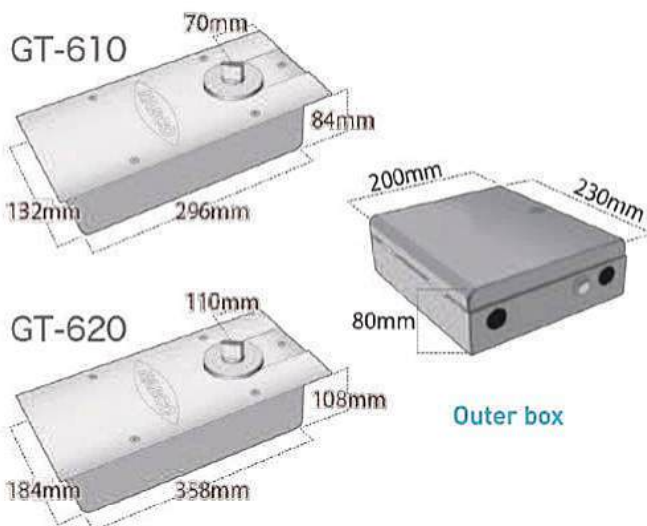



Product Features

1. Stable and silent opening or closing.
2. The door will open automatically after pushing it 2cm with hand.
3. Have excellent safety return function.
4. Can be easily opened in case of power failure.
5. If the door hits any person or obstacle during closing, it will immediately make a reverse motion.

Application Example

- Office building
 - Meeting room, smoking room, office entrance
- Factory
 - Clean room, meeting room
- Hospital welfare facility
 - Living room, consultation room, multi-purpose toilet
- Residence Villa
 - Kitchen, study, children's room, toilet, underground audio-visual room

Operation Principle Compared with Ordinary Automatic Doors

Traditional Drive device

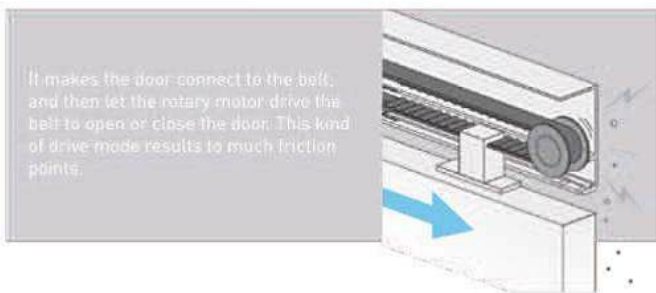

Automatic Magnetic Suspension Door

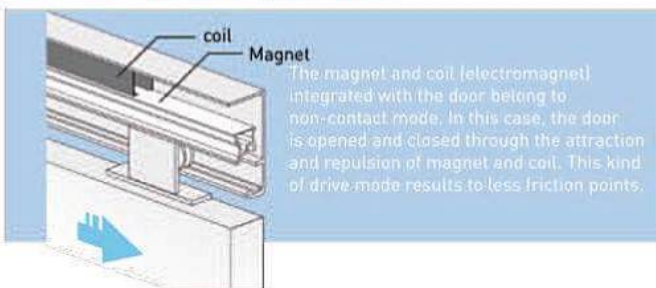

LS Automatic Magnetic Suspension Door

Details		
Model	LS-80	
Applicable door weight	20-80 kg/leaf	
Body Weight	About 8kg	
Power consumption	Average at the time of movement	0.2Wh/time (door weight: 50kg/leaf)
	Standby	Without pressing force: 2.8W (excluding sensor)
		With pressing force: 5.8W (excluding sensor)
Motor type	Permanent magnet linear motor	
Generated thrust	40N when the stator is fully wound three times	
Required power capacity	AC100V ± 10% 50/60Hz Max:4A	
Applicable door width	> 700mm (more than 830mm in case of installing the electronic lock)	
Operating temperature range	-10~40°C	
Opening speed	0.2-0.5m/Sec (factory default 0.4m/Sec)	
Closing speed	Fully automatic model: 0.2-0.5m/Sec (factory default 0.3m/Sec)	
	Multi-function model: 0.2m/Sec (fixed value)	
ON/OFF time	1-10 seconds, ratchet ON/OFF operation is performed when setting to the maximum value (factory default 3s)	

※ The weight will vary depending on the length of rail.



HDS-M

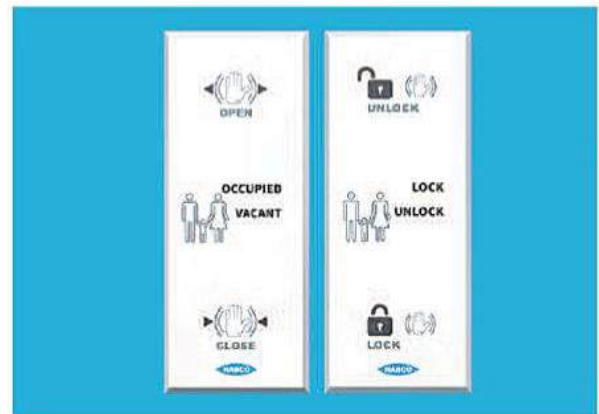

Product Features

1. Enhanced Accessibility: Designed to assist individuals with disabilities, our doors eliminate the hassle of manual opening and closing.
2. Voice Prompt Function: Equipped with voice prompts, our doors provide a thoughtful and caring service experience.
3. Automatic Locking for Security: The door automatically locks when in use, ensuring a heightened sense of security for users.
4. Auto-Controlled Lighting: Indoor lighting turns on and off automatically, eliminating the need for manual operation.
5. Operating Status Indicator: An external indicator informs others of the door's status, ensuring users' privacy.
6. Automatic Closure: If the door is not closed after use, it will close automatically after the setting time.
7. Automatic Unlocking: To prevent locking malfunctions, our doors are equipped with an automatic unlocking function.
8. Emergency Lock Release: In the event of an abnormal situation, the lock can be automatically released.
9. Administrator Key Access: Should special circumstances arise, the door can be opened from the outside using an administrator's key.
10. Emergency SOS Button: An emergency button is available inside the bathroom, ensuring the back door unlocks automatically when a distress signal is sent, facilitating timely rescue.

Application Example

- To enhance accessibility for special groups, including caregivers and individuals with disabilities, we recommend our hygienic and safe automatic induction doors. Designed with user comfort in mind, these doors provide a seamless entry experience.
- Widely used in stations, hospitals, airports, hotels, shopping malls and many other places, on the premise of fully considering the concerns of users and managers.



Note: The Clear opening for wheelchair access is recommended to be more than 900mm.



Product Features

1. Hermetic Door with Air Tightness, Aesthetics and Safety.
2. Unique sinking embedded mechanism to achieve high air tightness and meet the requirements of customers.

Application Example

- Operating room
 - Places with airtightness requirement
- Radiotherapy room
 - Used for radioactive ray shielding door
- Food factory
 - Used for HACCP
- Warehouse Factory
 - Used for the places with air conditioning management requirement
- Meeting room
 - Used for the places with silence requirement

NAX Sound-proof Performance (in case of single door)

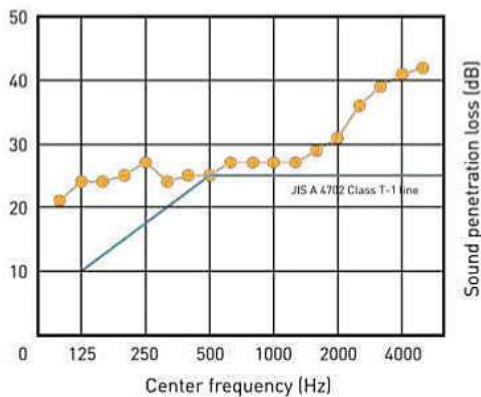

NAX Airtight Performance Graph (in case of single door)

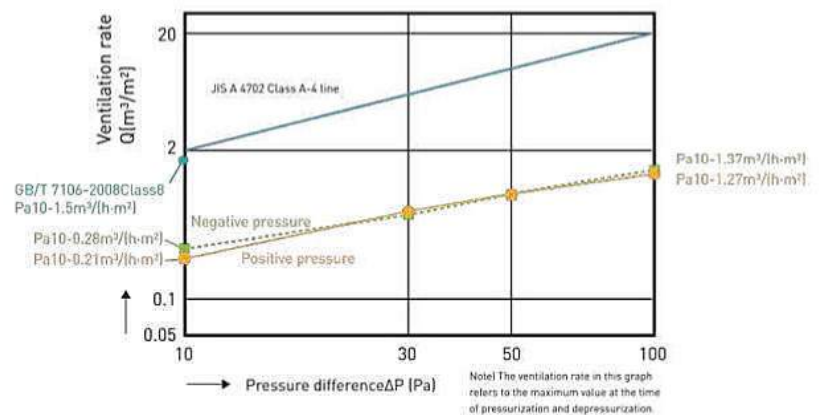

NAX Hermetic Door

Air tightness	-[Automatic door] Airtight performance (old Japanese specifications) JIS A 4702: Class A-4 ※ Equivalent to Chinese specifications GB/T 7106-2008 Class 8
Aesthetics	-Smaller electromechanical beam; -Multiple kinds of panel selections and handle selections.
Safety	-Not occupy effective passage opening, can be opened to the maximum degree without obstructing access; -Can be opened easily with hand in case of power failure.

Panel Style of Automatic Door

Please select your preferred automatic door panel from the following two types.

• Glass



• Aluminum



Detection Sensor (optional)

• Proximity Sensor (Non-contact)



• Foot Switch



The door opening and closing can also be realized with no need of touching it by hand.

NAX Hermetic Door

Details				
Application	Airtight + Sound-proof		Airtight + Sound-proof + X-ray shielding*2	
Door panel	Aluminum / Stainless steel/Glass		Aluminum	Stainless steel
Door Type	Bi-parting	Single	Bi-parting	Single
Clear opening width(mm)	Width (W)	700-2000	700-1600	700-1600
	Height (H)	1900-2500	1900-2500	1900-2500
Max weight	220kg			
Opening speed	Up to 0.7m/s			
Hold open time	Adjustable			
Ambient temperature	-10 C - 50 C			
Required power supply	220V AC± 10% 50/60Hz (when NABCO special transformer is used)			
Power consumption	45Wh			
Relative humidity	20% -85% RH			
Air permeability	A-4 [JIS A 4702] ※ Equivalent to Chinese specifications GB/T 7106-2008 Class 8			
Sound-proof performance	T-1 [JIS A 4702]*1		T-1 [JIS A 4702]	
X-ray shielding performance	-		○ (lead plate 2mm)	
Electric lock	○			

*1 The type of glass door leaf has T-2 class of sound insulation. If T-2 class is required for aluminum/stainless door leaf, please contact our sales distributor.

*2 As for "airtight + sound-proof + X-ray shielding", if the door larger than the specifications and dimensions is required, our company has to make special customization. Please contact our sales distributor.



Manual Opening

Even in the event of power failure, our doors can be manually opened easily by choosing the following 3 types handles.

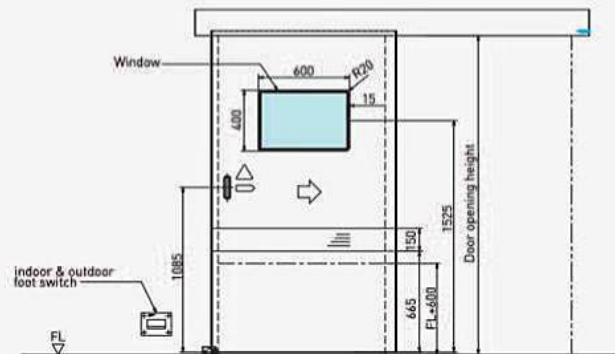
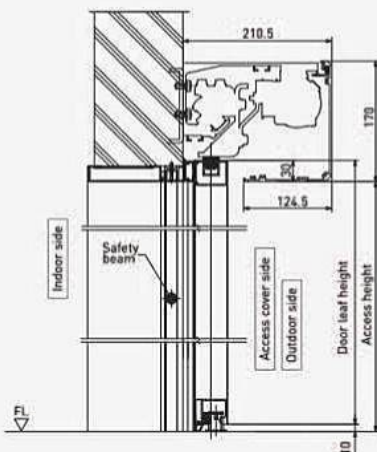



Product Features

1. Compact electromechanical beam with multiple handle options available.
2. Can be opened easily by hand in case of power failure, ensuring a wide opening; the embedded handle does not obstruct effective passage opening or obstruct access.
3. The whole door runs smoothly and quietly, with good sound insulation both indoors and outdoors.
4. The external electromechanical beam and door body are directly installed on the wall, ensuring quick and easy installation.

Application Example

- Operating room
 - Places with X-ray shielding requirement
- Food factory
 - Places with HACCP requirement
- Warehouse - Factory
 - Places with air conditioning management requirement
- Meeting room
 - Places with silence requirement

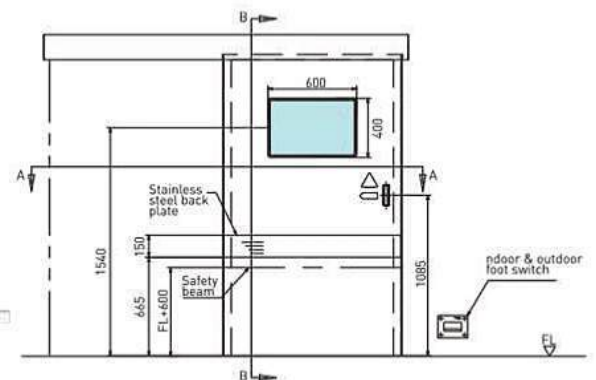
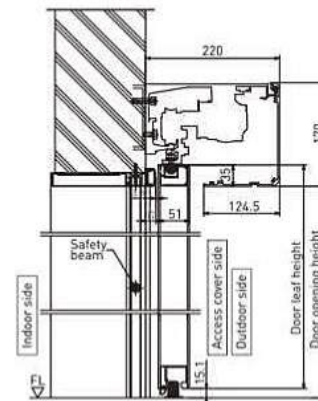

Medical Door

Device Model		Details				
Device Model		MD-S75	MD-S150	MD-SX1	MD-SX2	MD-SX3
Opening width(mm)	Width (W)	700-2000	700-2000	1000-1700	1000-1800	1000-1800
	Height (H)	1900-2500	1900-2500	1900-2500	1900-2500	1900-2500
Applicable single door mass		100kg	150kg	250kg	350kg	500kg
Opening speed		Average 0.4m/s				
Hold open time		Adjustable				
Ambient temperature		-10 C - 50 C				
Required power supply		220V AC± 10% 50/60HZ (when NABCO special transformer is used)				



Same Door Width & Larger Opening



Longitudinal Sectional View (built-in)

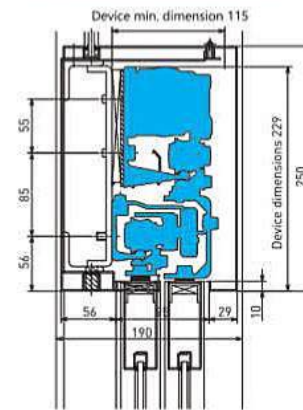

Note: For more details, please refer to Page 5.

VS-TP integrated beam

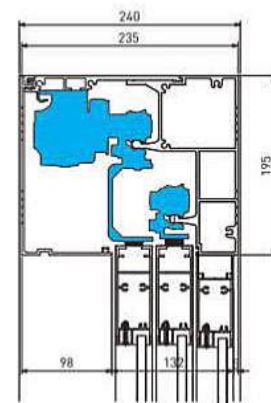

Product Features

1. With the same door width, its opening width is 1.3 times that of a standard sliding door
2. New slimmer design of header box made the appearance more aesthetic access feeling is well received by customers.

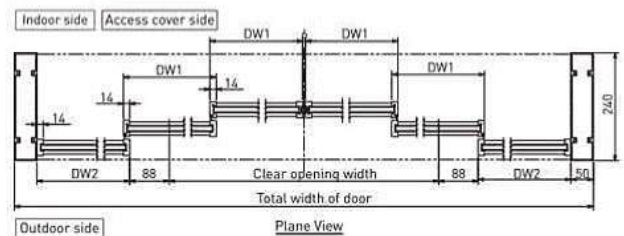
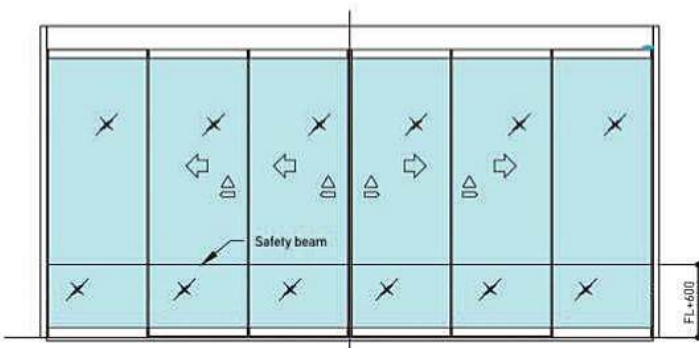

Double Telescopic Sliding Door

Device Model		VS-85	VS-150	VS-250	VS-85	VS-150	VS-250
Door type		Bi-parting			Single		
Maximum applicable door leaf	Single door weight (kg) × leaf quantity	55×4	100×4	165×4	55×2	100×2	165×2
	Single door area: DW × DH (m ²)	max.1.9	max.2.2	max.3.5	max.2.1	max.2.4	max.7
	Single door width: DW (mm)※	500-650	500-100	1000-1650	500-800	500-1000	1000-2000
	Single door DH/DW	max.1.9		max.3.0	max.1.9		max.3.0
Average opening and closing speed		<0.35m/s		<0.45m/s	<0.38m/s		<0.45m/s
Required power capacity		AC 220-2.5A		AC 220-5A	AC 220-2.5A		AC 220-5A

Note: The single door leaf width refers to the door leaf with stainless steel frame (door leaf coincidence size 50mm).

17 Triple Telescopic Sliding Door

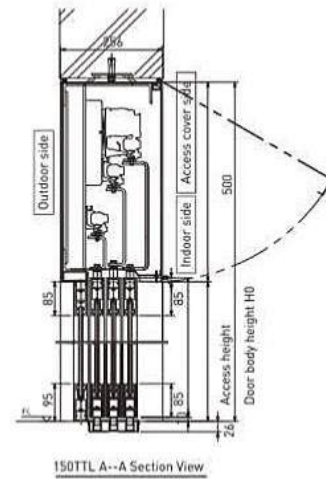
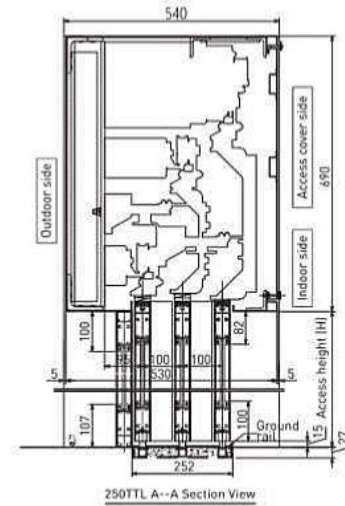

Product Features

1. Three movable leaves, ensuring more spacious access width.
2. Reducer mechanism is stable and reliable, ensuring smooth running and low noise.
3. Multiple kinds of specification, meeting different use

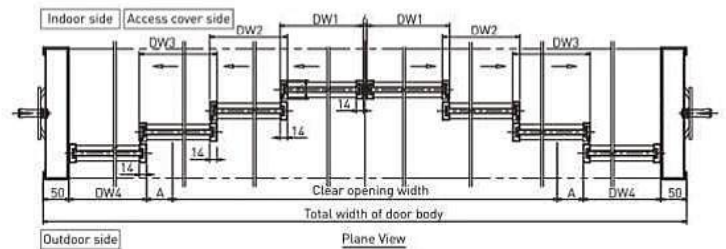
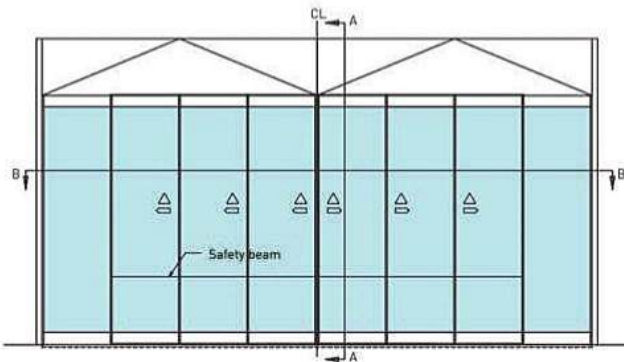

TTL Triple Telescopic Sliding Door

Device Model	VS-150	VS-250	VS-250 reducer type	VS-150	VS-250	VS-250 reducer type
Door type	Bi-parting three-leaf telescopic door			Single three-leaf telescopic door		
Single door weight (kg) × leaf quantity	60×6	100×6	150×6	75×3	125×3	185×3
Single door area: DW × DH (m ²)	max.1.6	max.3	max.4.5	max.2	max.3.5	max.4.5
Single door width: DW (mm)	600-850	600-1000	600-1400	600-850	600-1000	600-1400
Single door DH/DW	max.4	max.3	max.3	max.4	max.3	max.3
Average opening and closing speed	<0.35 m/s	<0.45 m/s	<0.22 m/s	<0.35 m/s	<0.45 m/s	<0.22 m/s
Required power capacity	AC 220V, 2.5A	AC 220V, 5A	AC 220V, 5A	AC 220V, 2.5A	AC 220V, 5A	AC 220V, 5A



Product Features

1. Japanese-imported drive unit (50mm) with reinforced aluminum frame, compliant with JIS A 4722 standards for high quality and safety.
2. High-strength sealed door structure prevents energy loss from air convection.
3. Compatible with up to 24mm hollow thermal insulation glass for improved energy efficiency and environmental friendliness.

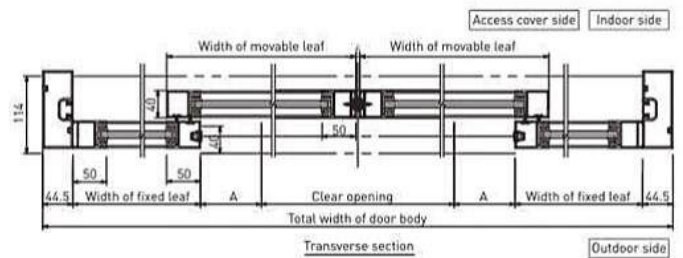

NAL-VS Reinforced Type

Item	Standard Configuration	Optional Configuration
Material	●	Aluminum
Door frame	●	50 mm
Jamb tube	●	44.5×114
Ground rail	⊙	Ground rail/Bottom guide
Glass material	⊙	Tempered (laminated/insulated)
Glass thickness	⊙	10mm [12mm/6mm+6mm/8mm+8mm/6mm+12A+6mm]
Starting probe	⊙	NH-203B (multiple kinds for selection)
Safety beam	⊙	NP-01(NP-80)
Surface treatment	⊙	Original material (can be coated)
Transom window	⊙	Optional
Program Switch	△	PGS-C/CL
Electronic lock	△	SKD-C
Floor lock	△	NDL-12
Emergency power supply	△	EBS

● Standard component ⊙ Standard optional component △ Optional component

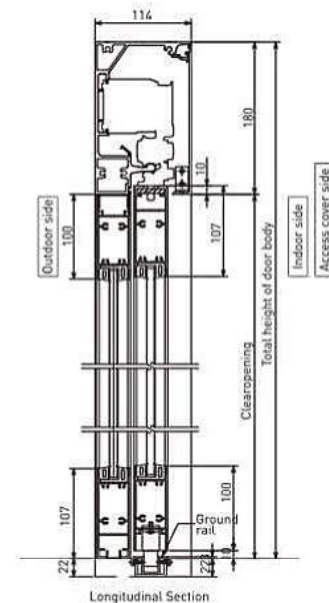



Product Features

1. Japanese-imported drive unit with LOSCAR aluminum frame(14mm), compliant with JIS A 4722 standard, ensuring high quality and safety.
2. Lightweight and elegant appearance, neat and generous.
3. High-strength sealed door structure with sealing strips, effectively preventing energy loss caused by indoor and outdoor air convection.

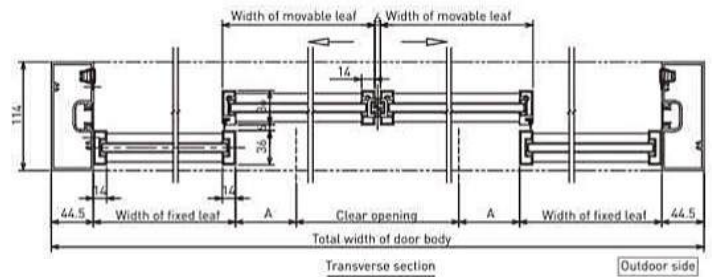

NLC-VS Slim Type

Item	Standard Configuration	Optional Configuration
Material	●	Aluminum
Door frame	●	14 mm
Jamb tube	●	44.5×114
Ground rail	◎	Ground rail/Bottom guide
Glass material	◎	Tempered (laminated optional)
Glass thickness	◎	10mm (12mm/5mm+5mm)
Starting probe	◎	NH-203B (multiple kinds for selection)
Safety beam	◎	NP-01(NP-80)
Surface treatment	◎	Original material (can be coated)
Transom window	◎	Optional
Program Switch	△	PGS-C/CL
Electronic lock	△	SKD-C
Floor lock	△	NDL-12
Emergency power supply	△	EBS

● Standard component ◎ Standard optional component △ Optional component

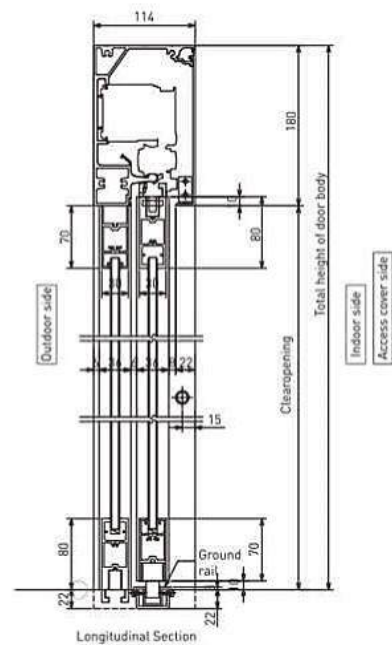



Product Features

1. Ideal for access control and automatic ticket machines in airports, subways, libraries, office buildings, theaters, factories, and recreational areas.
2. The swing gate features simple channel identification.
3. Effectively manages pedestrian access.
4. The system operates smoothly and quietly, compatible with various access control methods, including facial recognition, QR codes, M1 cards, barcodes, fingerprints, and ID cards.

NPKX Speed Gate

Details		
Model	NPKX-1 thin frame	NPKX-2 thick frame
Box Dimensions	1400 L x 155 W x 980 H mm	1600 L x 200 W x 1025 H mm
Passage width	600mm (customizable to 900mm)	650mm (customizable to 950mm)
Input signal	Dry contact signal, TTL signal, or low-level pulse signal with pulses wider than 100 milliseconds	
LED indicator board	4 pieces	
Waterproof and dustproof grade	IP33 or above	
Access speed	About 60 people/min (normally open) 40 people/min (normally closed)	
Supply voltage	AC220 ± 10% V, 50HZ	
Max. power	< 120W	
Motor	24V/30W Motor	
Communication interface	Serial port /485 port	
Operating temperature	-10 C ~ 60 C	
Operating environment	Operating indoor/outdoor (lawning required)	
Box material	304 SUS	
Shutter material	Tempered glass, acrylic, etc.	
Gate opening/closing time	Less than 0.3s	
Whole device service life	Continuous trouble-free opening and closing more than 5 million times	
Operating frequency	Suitable for long-term use in high frequency places	
Operating noise	< 55dB	



NPKX-1



NPKX-2

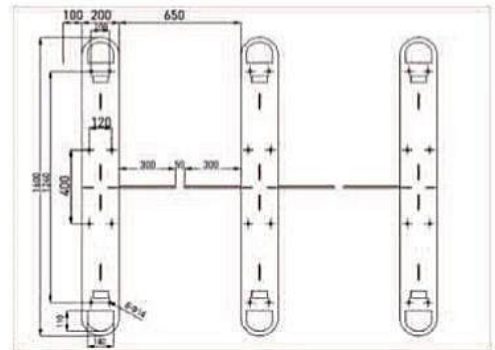
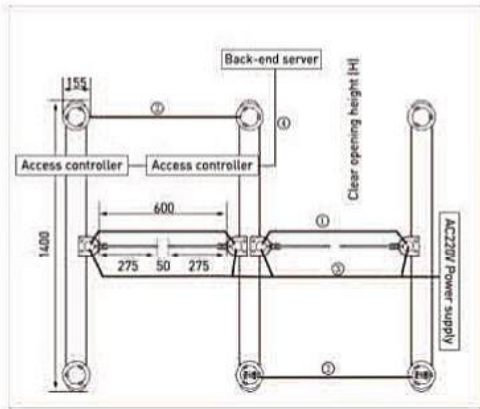

- ① Aisle light
- ② Access light
- ③ Lock top cap screw
- ④ Swing door
- ⑤ Side cylinder
- ⑥ Transmission cylinder
- ⑦ IR window
- ⑧ Top cap
- ⑨ Swiping card window

WARNING:

- 1. The synchronization cable and power line shall be laid away from the expansion screw fixing holes.
- 2. If the access controller is placed in the equipment room, pay attention to the cable routing between the card reader and the access controller. The cable should be laid from the card reader at both ends of the gate, instead of the middle movement position.



CS2A Series Two-wing Revolving Door

Item		CS2A-H Type Display Case at Both Sides Sliding Door in the Middle	CS2A-W Type Columns Around	CS2A-Z Type Display Case at Both Sides
Dimensions	Revolving diameter: D (mm)	2800-4800	3600-4800	2800-3600
	Sliding door clear opening width (mm)	1224-2224	1624-2224	1280-1680
	Passage height (mm)	2200-3000	2200-3000	2200-3000
	Canopy height (mm)	300-600	550-600	300-600
Drive device	Revolving speed	Standard revolving speed	Standard 3rpm (3-4rpm)	
		In case of opening/closing at low revolving speed	Standard 2rpm (2-3rpm)	
	Revolving direction	Anti-clockwise		
	Safety protection device	Door body sensor		Position anti-pinch sensor
		Auxiliary sensor		Emergency stop device
		Revolving stop device		Low-speed revolving switch
Rubber anti-pinch sensor			Sliding door switch (label and doorbell purchased separately)	
Required power capacity		AC220V-16A		
Operationable Standard maximum bearable wind speed		When the revolving door is in service: <25m/s When the sliding door is in service: <15m/s		

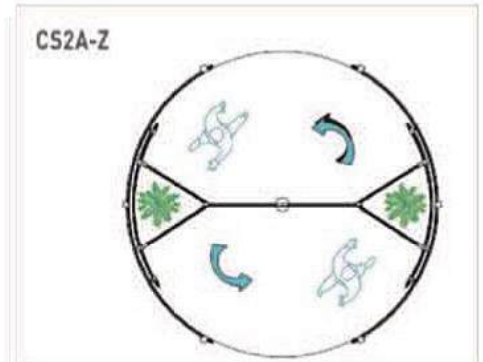
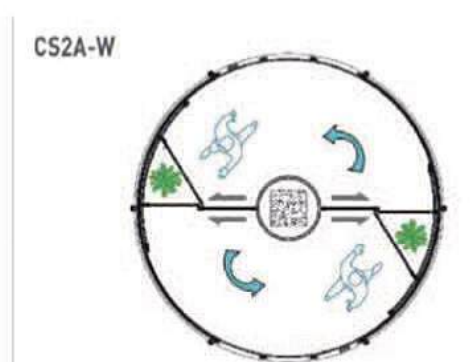
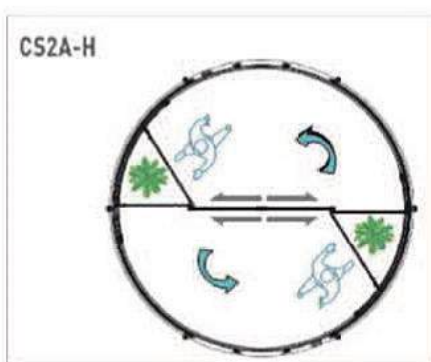



RL Series Three/Four Revolving Door

Item		RL-X (door leaf selectable with folding function)	RL-Z type with display case in the middle	RL-W Type with Columns Around
Dimensions	Diameter (ID) (mm)	1800-3600	2800-3800	3000-4200
	Three-wing access width (mm)	780-1680	1280-1780	1380-1980
	Four-wing access width (mm)	1195-2455	1895-2595	2035-2875
	Passage height (mm)	2200-3000	2200-3000	2200-3000
	Canopy height (mm)	300-600	300-600	500-600
Control drive device	Revolving speed	Standard revolving speed		Standard 3rpm (3-4rpm)
		In case of opening/closing at low revolving speed		Standard 2rpm (2-3rpm)
	Revolving direction	Anti-clockwise		
	Safety protection device	Door body sensor		Position anti-pinch sensor
Safety stop device		Rubber anti-pinch sensor		
Emergency stop device		Low-speed revolving switch		
Required power capacity		AC220V-16A		
Maximum bearable wind speed(H=2200mm)		<20m/s		

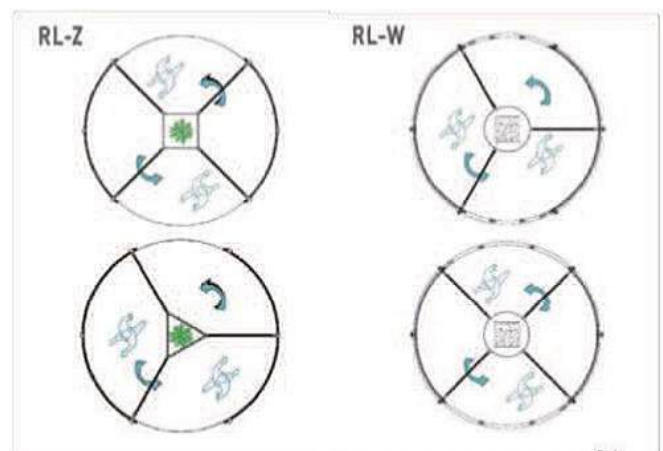
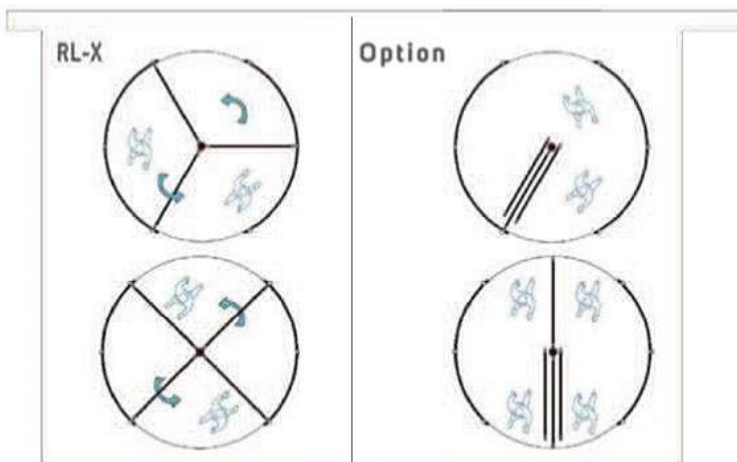



SSJ-A Three/Four-wing Crystal Revolving Door

		Details		
Dimensions	Revolving diameter (ID) (mm)	1800-3000		
	Three-wing access width (mm)	780-1380		
	Four-wing access width (mm)	1195-2035		
	Passage (mm)	2200-3000		
	Canopy height (mm)	70 [sensor built in] 75 [sensor external mounted]		
Control drive device	Revolving speed	Standard revolving speed	Standard 3rpm [3-4rpm]	
		In case of opening/closing at low revolving speed	Standard 2rpm [2-3rpm]	
	Revolving direction	Anti-clockwise		
	Safety protection device	Door body sensor	Position anti-pinch sensor	
		Safety stop device	Rubber anti-pinch sensor	
Emergency stop device		Low-speed revolving switch		
Required power capacity		AC220V-16A		
Maximum bearable wind speed(H=2200mm)		<15m/s		

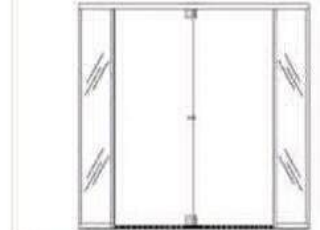
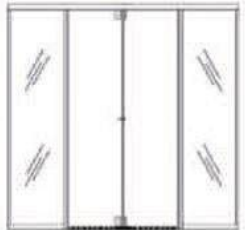
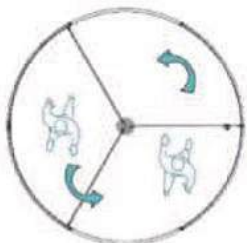



Attractive Design of Curved Structure



Product Features

1. It has the excellent characteristics of sliding automatic door, and creates a wonderful atmosphere with its curved structure.
2. In the limited total width of door body, the opening amplitude is significantly increased, which facilitates the miniaturization of the air removal chamber.

Circular Door

Device Model		VS-85		VS-150	
Door type		BI-parting Sliding		Single Sliding	
Door type	Single door weight (kg) × leaf quantity	75×2	100×2	75×1	100×1
	Single door area: DW × DH (m ²)	max.2.6			
	Single door width: DW (mm)	762-1067※			
	Single door DH/DW	max.3.0			
Average opening and closing speed		<0.4m/s			
Required power capacity		AC 220V-2.5A			

※ The occasion which uses tempered glass

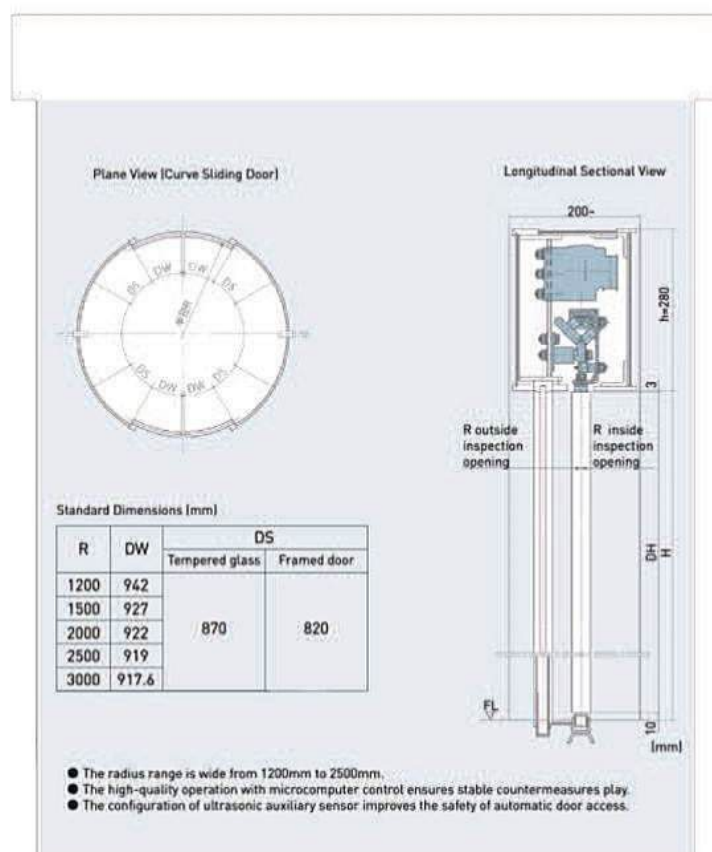

Floor Spring

Model	NFH-100	NFH-150	NFH-220	NFH-300
Door leaf applicable width	1000mm-2500mm	1200mm-2700mm	1250mm-2800mm	1400mm-3500mm
Maximum load bearing of door leaf	100kg	150kg	220kg	300kg
Outline dimension	268mm*125mm*48mm	306mm*130mm*41mm	291mm*160mm*51mm	357mm*114mm*65mm



NFH-100



NFH-150

Ground Lock

Model	NDL-12	Model	NDL-11
-------	--------	-------	--------



NS-A01 Transom Mount Sensor

It is a kind of automatic door probe that integrates Japanese technology, peace of mind, safety and comfort.

Detection mode	Near infrared reflection mode (dynamic & static induction)
Maximum installation height	4.0 m
Maximum detection area	5.2m width × 3.3m depth (reference value)
Power consumption	<DC12V 120mA
Remarks	Set with independent area, so as to correspond to irregular doors; Be configured with self-diagnosis and non-touch sensing functions; Be equipped with snow and insect prevention measures as well as eco mode.



NS-A04 Ceiling Mount Sensor

As a ceiling mounted product, it can be installed on the ceiling close to the door body, thus expanding the design freedom. In addition, it is integrated with ceiling spotlights to improve the overall aesthetics. Based on its convenient installation and dismantling, it is another popular sensor after the beam-mounted type.

Detection mode	Near infrared reflection mode (dynamic & static induction)
Maximum installation height	4.0 m
Maximum detection area	3.2m width × 3.2m depth (reference value)
Power consumption	<DC12V 700mA
Remarks	Have self-diagnosis function



NH-721 Ceiling Mount Sensor for Super High Door

It is specially used for super high doors up to 5m, and is installed on the ceiling

Detection mode	Near infrared reflection mode (dynamic & static induction)
Maximum installation height	4.0m-5.0m
Maximum detection area	5.2m width × 3.3m depth (reference value)
Power consumption	<DC12V 120mA
Remarks	Set with independent area, so as to correspond to irregular doors; Be configured with self-diagnosis and non-touch sensing functions; Be equipped with snow and insect prevention measures as well as eco mode.



NS-A02 Transom embedded Sensor

It is a kind of automatic door probe that integrates Japanese technology, peace of mind, safety and comfort.

Detection mode	Near infrared reflection mode (dynamic & static induction)
Maximum installation height	4.0 m
Maximum detection area	5.2m width × 3.3m depth (reference value)
Power consumption	<DC12V 120mA
Remarks	Set with independent area, so as to correspond to irregular doors; Be configured with self-diagnosis and non-touch sensing functions; Be equipped with snow and insect prevention measures as well as eco mode.

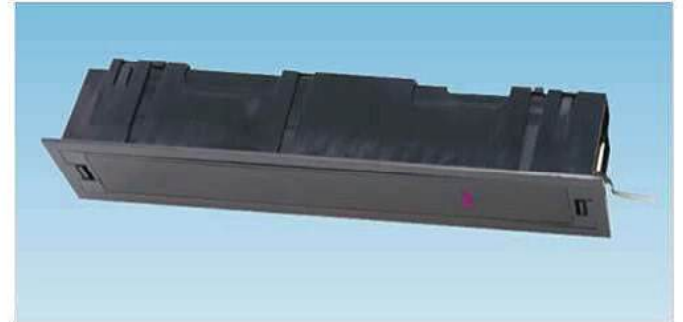

NSW-A01 Transom Mount Sensor

The combined use of infrared and image sensors, the sensor detection area has expanded 4 times. This new sensor precisely detects the movement of people and open only for people wanting to pass through.

Detection mode	Near infrared reflection mode (dynamic & static induction)
Maximum installation height	3.5 m
Maximum detection area	5m width × 4m depth (reference value)
Power consumption	<DC12V 200mA
Remarks	Have self-diagnosis function; Full color LED light action



OA-215V Transom Mount Sensor

It detects objects through the reflected invisible light. Based on its quick detection, it can detect both dynamic and static objects. It is a kind of product widely used in Japan.

Detection mode	Near infrared reflection mode (dynamic & static induction)
Maximum installation height	3.0 m
Maximum detection area	4.0m width × 3.2m depth (reference value)
Supply voltage	12-110V AC/DC±10%
Power consumption	<2.0W (<5VA/AC)
Remarks	Have self-diagnosis function

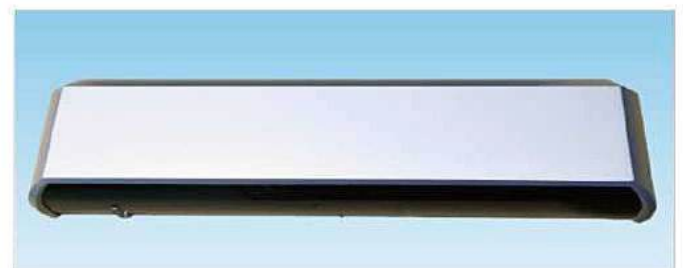

HW-TC Touch Sensor

There is a small wireless transmitter installed in the touch pad. The wireless touch sensor is a touch pad mounted on the automatic door by tapping it, and the radio wave is transmitted from the information output part of the touch pad to the receiver connected to the door opening and closing device, so as to realize the opening and closing of automatic door. The opening and closing device from the touch pad to the door body doesn't need to be installed with signal cable, so it reduces the trouble of cable moving and connection, and you only need to drill the installation hole during processing.

Detection mode	Pressurization detection (compression plate)
Information mode	Radio wave [310MHZ]
Standard wireless transmission distance	5.0 m
Maximum detection area	Receiver: <AC80-20V 2VA, <DC12/24V 50mA Transmitter: 7# alkaline battery
Output capacity	Output contact 1a DC50V/0.1A (resistive load)
Remarks	The battery life of transmitter is about 3 years (500 times of use per day), antibacterial specifications.



HW-NC Proximity Sensor (Non-contact)

- Standard 86 type switch panel with wireless/wired design, ensuring more flexible installation.
- The transmitter is designed with low-power emission technology, ensuring long transmission distance, low power consumption and long battery service life.
- The blue light will be on if the remote control is valid, which can be used to confirm whether the switching is valid.
- Adjustable sensing distance (3~30cm).



FT-80B Foot Switch

Facilities related to hospitals and food can use the kicking sensor to open automatic doors; The kicking sensor is usually suitable for airtight doors (NAX series) and ordinary medical automatic doors.

Detection mode	Photoelectric mode
Operation mode	Foot inserting
Power consumption	<AC100V 2VA
Output capacity	AC100V 0.5A(resistive load) DC24V 1.0A (resistive load)
Remarks	Operating force 0 N



APS-A10 Program Switch

- Color LCD display, providing excellent vision for door opening and closing.
- Can quickly and easily change the door status, such as opening/closing speed and opening holding time and so on.
- Can quickly access to door details, making maintenance and troubleshooting easier and faster.
- Multiple languages available, including Chinese, English, Korean, Thai, Vietnamese, Indonesian and Russian.
- Dimensions: 88×88×16.5 mm



PGS Program Switch

A small wall-mount switch is added to make the automatic door be used more easily. This new type of switch is simple to operate, and can be switched repeatedly at will according to the needs of users. Besides, its security protection with a lock can effectively prevent irrelevant personnel from changing its operation mode.

5-mode switch:

- 1) AUTO: general mode
- 2) F-OPEN: open holding mode
- 3) ONE WAY: one-way access mode
- 4) P-OPEN: half open mode
- 5) CLOSE: closed holding mode



PGS-C (85*85)



PGS-CL (135*45)

SKD-T10U Electronic Lock

Input power supply	AC100V / 1A
Electronic lock current consumption	Starting state: 900mA Normal state: 350mA
Door lock delay time	0-9s (can be set by the user), factory value: 2.5s
Signal output	Used to Trigger automatic door, normally open contact output (N.O) to withstand 1A current
Safety measures	[1] Power-off open safety electronic lock; [2] There is optical coupling opening input button contact built in, if the door is not opened within 5 seconds, it will automatically be locked again.
Sensor signal delay time	After the sensor detects the electronic lock stopper, the signal holding time can be adjusted on the electronic lock.



NP-01 Safety beam

The starting sensor of automatic door is mainly used to start the equipment, while the auxiliary sensor is to protect the object passing or staying in the door body from being pinched, thus improving the safety of automatic door.

Detection mode	Dynamic, static detection (single light ray)
Installation height	Standard FL (ground) +600
Maximum detection area	Light projector/receptor distance 5.0m
Power consumption	< DC12V 50mA
Output capacity	Collector output DC30V 0.1A (resistive load)



EBS Emergency Operating System

EBS is the emergency power supply device for NET-VS series automatic doors. In case of power failure or emergency signal (DC24V) input, the drive power of the automatic door is provided by the built-in power supply to keep the automatic door open (or closed). After the normal power supply is restored, the automatic door will be restored to the state before power failure, and after the emergency signal is released, the reset switch will be switched on to return to the normal state of use.

Features:

- The device is built in the electromechanical beam, with the features of compact structure and convenient installation.
- You can choose to provide normally open or normally closed signal to the automatic door in case of power failure or emergency signal input, so that the automatic door is open or closed.
- The charging and power working status LED indicators are set on the body, which is convenient to confirm the power supply status and battery working status.
- The emergency power supply adopts small fully-sealed and maintenance-free Ni-Cd battery.



PL-T10U Driven Pulley Lock

The driven pulley electromagnetic lock locks the special drive belt of automatic door, so as to keep the automatic door leaf closed. Since its components operate with low sound and low failure rate, it can be used safely.

Unlock feature	Power failure release
Unlock construction	Electromagnetic lock
Input signal	1A current, automatic door linking
Indicator light	Release light red, displayed on the controller
Unlock monitoring output	No voltage A power supply
Remarks	Be used with PLC-N controller

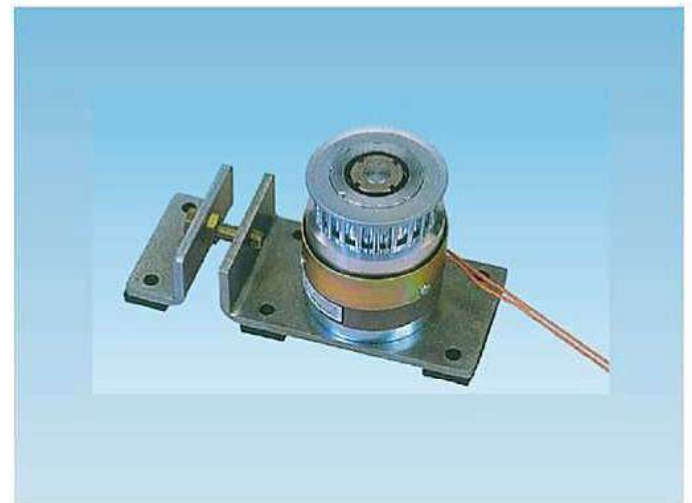



CE Certification



ISO9001



ISO14001

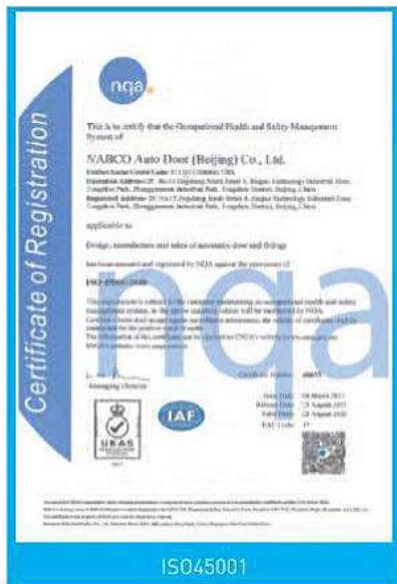

ISO45001



TUV Certification

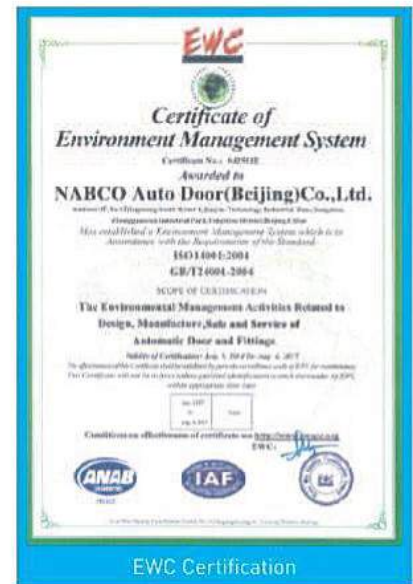

EWC Certification



Test Report of Automatic Emergency Evacuation Door



Airtight Door Certification - Japan Testing Center for Construction Materials



Airtight Door Testing Based on European Standard - Hong Kong Curtain Wall Testing Centre Ltd

Transportation (Airports, Train Stations & Bus Stations)



Beijing Capital International Airport



Beijing Daxing International Airport



Shenyang Taoxian International Airport



Harbin Taiping International Airport



Tianjin Binhai International Airport



Vietnam Phu Bai International airport terminal2



Vietnam Da Nang International Airport



Hangzhou International Airport



Shanghai Pudong international Airport



Shanghai Hongqiao International Airport



Korea Incheon International Airport



Nanjing High-speed Railway Station

Hospitals



Beijing Cancer Hospital



Beijing Tsinghua Hospital



Shanghai Renji Hospital



Shanghai Sixth People's Hospital



Shanghai Deda Hospital



Shanghai Jiahui International Hospital



Korea Samsung Hospital



Affiliated Hospital of Harbin Medical University



Korea Hospital Yonsei University Health System



Malaysia Island Medical City



Thailand Ruamjairak Hospital



Indonesia Rumah sakit Universitas Indonesia

Residences



Shanghai Yanfeng
East Suburb Garden Landscape



Sunzhou Hefeng Yazhi



Hangzhou wulin No.1



Zhengshang Smart City
Wisdom Garden



Zhengzhou Zhengshang Smart
City Experience Area Outside



Zhengzhou Zhongzhou City Lily
Garden Entry Door Outside



Zhengzhou Yongwei
Community Gate



Yaxin Wisteria Mansion
Sales Office

Supermarkets&Convenience Stores



Tesco



Vietnam AEON Mall Ha Dong



Vietnam AEON MALL Hai Phong



Haikou Carrefour Supermarket



Vietnam SC VivoCity
Shopping Mall



Lawson Convenience Store



Sam's Club Store



Beijing Sanlitun Uniqlo Store

Public facilities&Factories



Guangqi Honda Factory
Suzhou Eisai



Vietnam Capital place



Daiichi-Sankyo
Pharmaceutical Factory



Tianjin FAW Toyota Co., Ltd.



Ministry of Railways
Settlement Center



Shanghai NO.2 Intermediate
People's Court



Guiyang Customs



Vietnam muRata factory

Office Buildings & Shopping Malls



Beijing Sheraton Hotel



Crowen Plaza Beijing
Chaoyang U-Town



Ramada Shanghai Hotel



Hangzhou City Square Hotel



Grand Mercure Hotel
Front Door



Xiamen Grand Kempinski
Hotel



Macau Galaxy Hotel



Jiujing Hotel

Supermarkets&Convenience Stores



Vietnam BRG Tower



Vietnam FLC Sea Tower
Quy Nhon



Shanghai World Financial
Center



Shanghai HSBC Tower



Binhai International
Convention and Exhibition Center



Hangzhou Yinxinhui Building



Guangdong Qingyuan
Lexus 4S SHOP



Hangzhou Yongan Building

Revolving door



Xiamen Ruida Financial
Center



Dailan Development Zone
Management Committee



Vietnam La Festa Phu Quoc



Vietnam Sun World Ba Na Hills



Shanghai Zhendan Building



Shanghai Bank of China Tower



Jinzhou Public Security Building



Xi'an Xianyang
International Airport Customs

History

Development History

- 2023 Nabtesco 20th anniversary
- 2019 Production of NABCO Automatic Doors was reached at 2500,000 units
- 2011 Entered the European market by Gilgen
- 2005 NABCO Autodoor (Beijing) Co., Ltd. was established and operated solely by Japan.
- 1995 Entered the mainland China market by NABCO Autodoor Beijing
- 1992 Entered the North American market by NABCO Entrances
- 1986 Lusca product of Japan Nabtesco was selected as "GOOD DESIGN" product by the Ministry of International Trade and Industry for the first time in the industry.
- 1963 Japan Nabtesco sold hydraulic automatic sliding door device "Mini Super".
- 1961 Japan Nabtesco sold air automatic sliding door device DP model.
- 1957 Japan Nabtesco established three-major-sales company system.
- 1956 Automatic door Japanese domestic No. 1 machine was set.
- 1953 Japan Nabtesco established automatic door technology cooperation with USA.

Company Profile of NABCO

NABCO manufactured the first automatic door in Japan and is now the major automatic door manufacturer in the world. NABCO has No.1 market share approximately 50% in Japan over the years.

Since NABCO manufactured the first automatic door in Japan in the 1950s, NABCO have developed a vast range of products for different applications and provided best services to our customers, which has made NABCO the "OnlyOne" automatic door solution provider.

Global Business

NABCO is a global automatic door enterprise that manufacture and sell automatic doors with Asian network and 3 subsidiaries, NABCO Entrances Inc. in North America, Gilgen Door System AG in Switzerland and NABCO Auto Door (Beijing)Co., Ltd. in China.



NABCO Headquarters in Japan



Konan plant in Japan



NABCO Autodoor (Beijing) Co., Ltd.



Shanghai branch



Guangzhou branch

To property management staff

In order to remind passerby to pay attention to the safety, please paste "Warning Sign" and "Automatic Door Sign" on the automatic door.



NABCO automatic doors and sensors are developed and designed with the basic concept of "human safety and comfort", but unexpected accidents can also occur if not used properly. In order to ensure the safety and comfortable use of automatic door device, please read the product instructions carefully before using the device. We hope it will become your eternal companion in the life.

Please set the auxiliary sensor

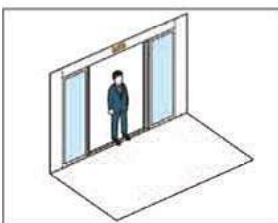

1. Please don't stop at the door.

Because it is not easy to detect the presence of someone between the door bodies, the door body may be improperly closed due to the sensor judgment error, thus resulting to pinching accident. Therefore, don't stand and talk in the doorway.



4. Please don't hold the door with hand.

Please don't lean on the door or pull the door with your foot. Your hand is easy to be pinched at the door edge and corner during door opening and closing. Please be careful.

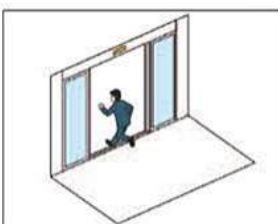

2. Please don't enter the door quickly.

The sensors can sense the presence of person, but cannot immediately make the door open. Don't thrust yourself in before the door is fully open or when the door is in the process of closing.

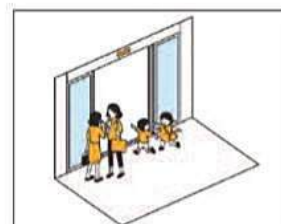

5. Please don't play at the door.

Children always feel that the door opening and closing is interesting, so they play nearby. Once their hands are pinched by the door, it is very dangerous. Please remind them timely if you find any children playing nearby the door.



3. Please don't enter the door from diagonal direction.

The oblique plane and side plane of the door body are the dead angles of sensor, which may cause people to collide with the door body due to the slow opening and closing of the door body. Therefore, please pass the automatic door from the front.

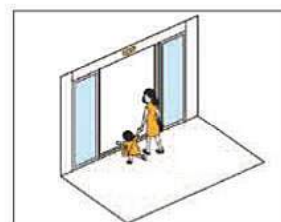

6. Please help people in need.

Adults should hold their hands when children pass through automatic doors. When the elderly and disabled pass through the door, people around should take the initiative to help them.

Nabtesco

NABCO Autodoor (Beijing) Co., Ltd.

2F, Liando U Valley, No. 15, Jingsheng South 4th Street,
Maju Bridge, Tongzhou District, Beijing

Postcode: 101102

Consulting hotline: 4001542734

Tel: 010-6050-3958

Fax: 010-6050-3968

<https://nabco.nabtesco.com/en/>



Nabtesco Corporation Accessibility Innovations Company

JA Kyosai Bldg.

7-9, Hirakawacho 2-chome

Chiyoda-ku

Tokyo 102-0093, Japan

Tel: 81-3-5213-1156

